



CR06 100mm 6 Channel Strip Chart Recorder Instruction Manual ver. 1.1 February 2007



FEATURES

- 6 Channel Dot Printing
- Large LED display; 18mm/0.71" High
- Universal Input
- Short Depth: 150mm/5.9"
- DIN Panel Cutout 138 x 138mm
- IP65/Nema 4
- RS232 Standard, 485 Modbus optional
- UL, CSA and CE

CR06 Instruction Manual Ver 1.1



P.O. Box 1196 – Bridgeview, IL 60455
888.751.5444 – 888.307.8014 fax
866.342.5332 Technical Support
<http://www.futuredesigncontrols.com>

For safety using

Thank you for purchasing our CR06 Hybrid Recorder.

In order to this instrument to exhibit all of its functions effectively and correctly, read and understand this instruction manual thoroughly before using the instrument.

The symbols below are used on this instrument for the cautioning information.

Symbols used on the instrument	
	This shows "Caution for handling". This symbol is used on the parts need to reference the instruction manual for saving human body and the instrument.
	This shows "Protective grounding". Be sure to provide protective grounding prior to operate this instrument.
	This shows "Risk of electric shock". This symbol is used on the parts, which has a risk of electric shock.

Be sure to observe the following warnings/cautions and those provided in the text in order to secure safety in handling the instrument.	
 WARNING	
General	In order to prevent electric shock; be sure to disconnect this instrument from the main power source when wiring it.
Protective Grounding	<ol style="list-style-type: none">(1) In order to prevent an electric shock; be sure to provide protective grounding prior to turning on this instrument.(2) Do not cut a protective grounding conductor or disconnect protective grounding.
Power Source	<ol style="list-style-type: none">(1) Make sure that the supply voltage for this instrument conforms to the voltage of the supply source.(2) Attach a protective cover prior to turning on this instrument.
Working Environment	Do not operate this instrument in the environment where it is exposed to a combustible/explosive/corrosive gas or water/steam.
Input and Output Wiring	Provide input and output wiring after turning off the power.



CAUTION

Input and Output Wiring

Do not use empty terminals for other purposes such as relaying, etc.

Inside of Instrument

Do not touch the switches, etc. inside this instrument. Also, do not replace the main unit or PRINTed circuit boards. When this is neglected, we cannot guarantee functioning of the instrument. Contact our dealer where you purchased the instrument, or our sales representative.

Transportation

When transporting this instrument or the equipment with this instrument incorporated in it, take measures to prevent opening the door and falling out the inner module.

[Note]

Instruction Manual

- (1) Deliver this instruction manual to an end user.
- (2) Prior to handling this instrument, be sure to read this manual.
- (3) If you have any questions on this manual or find any errors or omissions in this manual, contact our sales representative.
- (4) After reading this manual, keep it carefully by the instrument.
- (5) When the manual is lost or stained, contact our sales representative.
- (6) It is prohibited to copy or reproduce this manual without our permission.

Installation

- (1) When installing this instrument, put on a protective gear such as safety shoes, helmet, etc. for your safety.
- (2) Do not put your foot on the installed instrument or get on it, because it is dangerous.

Maintenance

Only our serviceman or persons authorized by Brainchild are allowed to remove and take the inner module, the main unit and PRINTed circuit boards apart.

Disposal

- (1) Dispose the replaced batteries in a correct way.
- (2) Do not incinerate plastics of maintenance parts and replacement parts. A harmful gas may be produced.

Cleaning

- (1) Use dry cloth to clean the surface of this instrument.
- (2) Do not use any organic solvent.
- (3) Cleaning the instrument after turning off the power.

Revisions

This instruction manual is subject to change without prior notice.

Using procedure for this manual

1.Using procedure

This instruction manual consists of “For safety using”, “Contents” and “Chapter 1 to Chapter 11” as bellow.



Read the applying sections for your purpose to use this instrument.

Chapter and TITLE	For purchase and install	For initial setting and change setting	For daily operation	For using communication	For maintenance and trouble-shooting
For safety using (page 1)	◎	◎	◎	◎	◎
1. INTRODUCTION	◎				
2. CONSTRUCTION	○	○	○		○
3. INSTALLATION	◎		○		
4. WIRING	◎	○	○	○	○
5. PREPARATIONS FOR OPERATION		○	◎		
6. OPERATION		○	◎		
7. DEVICE SETTING		◎		○	○
8.COMMUNICATIONS				◎	
9. MAINTENANCE					◎
10. TROUBLESHOOTING		○			◎
11. SPECIFICATIONS	○	○			○

◎ :Be absolutely certain to read this.

○ :Be certain to read this if you need.

The symbols below are used on the warning and cautioning information in this manual.

Symbols used on this manual	
 WARNING	Failure to observe this information could result in death or injury. Be absolutely certain to read this.
 CAUTION	Failure to observe this information could damage the instrument. Be certain to read it.
[Note]	This is cautionary information for correct use of the instrument. Be certain to read it.
[Reference]	This is information to help you use the functions of this instrument more effectively.

2.Guid of Instruction manual

The instruction manuals of this instrument are as the table below.

	Name	Part No.	Outline
This ⇒ manual	1 CR06 Hybrid Recorder (DOTTING type) instruction manual	MANUAL CR06	Explanation for installing, wiring, standard operation. And setting or operation for using this instrument.
	2 CR06 Hybrid Recorder Communication Command instruction manual	HXPRM10mnC0005E	Explanation for reading and writing data of the recorder by communication function.

CONTENTS

1. INTRODUCTION.....	6	7. DEVICE SETTING	40
1.1 Checking the Accessories.....	6	7.1 Setting the Setup Mode.....	40
1.2 Checking the Type and Specifications	7	7.1.1 Setting the Range	43
1.3 Temporary Storage.....	8	(1) Setting method	43
1.4 Indication Card.....	8	(2) HOLt (Current/Voltage), tC (Thermocouple),	
2. CONSTRUCTION	9	rtd (Resistance Temperature Detector).....	44
2.1 Appearance	9	(3) SCALE (Scaling)	46
2.2 Display Screen and Operation Keys	10	(4) SqRt (Square Root)	48
2.2.1 Display Screen	10	(5) dECAd (Decade)	50
2.2.2 Operation Keys.....	11	(6) dELt (Difference), Sr Qr (Sum),	
3. INSTALLATION.....	12	AEAr (Average).....	52
3.1 Outside Dimensions Drawing		(7) SkP (Skip)	53
and Panel Cutting Dimensions.....	12	7.1.2 Setting the Alarm	54
3.2 Mounting to the Panel	13	7.1.3 Setting the Unit	56
3.2.1 Procedure for Mounting to the Panel	13	(1) Character Code Table	57
3.2.2 Mounting to the Panel in compliance with the IP65.....	14	7.1.4 Setting the Chart Speed	58
4. WIRING	15	7.1.5 Setting the Date and Time	59
4.1 Terminal Layout and Power Wiring	15	7.1.6 Copying the Setting Data.....	60
4.1.1 Terminal Layout	15	7.1.7 Setting Other Functions.....	61
4.1.2 Power Wiring	15	(1) ErEnd (Printing Cycle)	62
4.1.3 Wiring Procedure.....	16	(2) zOnE (Zone Recording).....	62
4.2 Input Wiring.....	17	(3) PARt (Partial Compression/Expansion)	63
4.2.1 Wiring Procedure.....	18	(4) Prnt (Digital Print).....	64
4.3 DI/Alarm Output Wiring (Option).....	20	(5) tAG (Tag)	65
4.3.1 DI/Alarm Output Wiring Example	20	(6) CRnt (Comment Words).....	66
4.3.2 Alarm Output Wiring Procedure.....	21	7.2 Setting the Engineering Mode.....	67
4.3.3 DI Wiring Procedure.....	21	7.2.1 Alarm Hysteresis.....	70
4.4 Communication Wiring.....	22	7.2.2 Burnout ON/OFF.....	70
4.4.1 RS-232C Wiring	22	7.2.3 Channel Offset	70
4.4.2 RS-485 Wiring	22	7.2.4 Reference Junction Compensation	71
5. PREPARATIONS FOR OPERATION.....	23	7.2.5 Changing the Printing Color	72
5.1 Setting the Chart Paper.....	23	7.2.6 Settings Related to Recording.....	73
5.2 Setting the Ribbon Cassette	29	(1) Recording start/stop trigger setting.....	73
6. OPERATION.....	31	(2) Tag/channel print selection.....	73
6.1 Operation	31	(3) Alarm print ON/OFF	74
6.1.1 Status after Initial Screen.....	31	(4) Logging print ON/OFF	74
6.2 Recording.....	32	(5) Scale print ON/OFF.....	75
6.2.1 Recording Colors.....	32	(6) Logging print Synchronous/Asynchronous.....	75
6.3 How to Record.....	32	7.2.7 Setting the Communication Function.....	76
6.3.1 Starting/Stopping Recording Operation.....	32	7.2.8 Initializing the Setup Data	76
6.3.2 Feed the Chart Paper.....	32	7.2.9 DI Functions	77
6.3.3 Print Sample	33	7.2.10 Temperature Unit	77
6.4 Digital Print	34	7.2.11 Point Calibration	78
6.4.1 Manual Print.....	34	7.2.12 Data Calibration	79
6.4.2 List Print.....	35	7.3 Terminating the Engineering Mode.....	81
6.4.3 Engineering List Print	37		
6.5 Changing the Display	39		
6.5.1 Auto Display < Auto >	39		
6.5.2 Manual Display < MAN >.....	39		
6.5.3 Date Display < DATE >	39		
6.5.4 Time Display < TIME >.....	39		
6.5.5 Display Off < OFF >.....	39		

8. COMMUNICATIONS	82	10. TROUBLESHOOTING.....	94
8.1 General Description.....	82	10.1 Troubleshooting	94
8.1.1 General Description of Functions	82	10.1.1 Trouble Items	94
8.1.2 Transmission Specifications.....	82	10.1.2 When the Recorder Dose not Work at All	94
8.1.3 Data Construction.....	82	10.1.3 When there is a Big Error	95
8.2 Opening/Closing the Link.....	83	10.1.4 When the Trend Recording Deflected	95
8.2.1 Open Command.....	83	10.1.5 When Records Nothing.....	96
8.2.2 Close Command.....	83	10.1.6 When Recording is Faint.....	96
8.3 Outputting the Process Variable Data	84	10.1.7 When the Chart Paper is not fed at All.....	97
8.3.1 Specifying the Process Variable Data Output	84	10.1.8 When the Chart Paper is not fed Properly.....	97
8.3.2 Updating the Data.....	84	10.2 Self Diagnostics Function (ERROR).....	98
8.3.3 Specifying the Process Variable Data Output Order (At BINARY Mode Output).....	84	10.2.1 Self Diagnostic Items	98
8.3.4 Outputting the Data	84	10.2.2 Error Display.....	99
8.3.5 Process Variable Data Transmission Format (ASCII)	85	11. SPECIFICATIONS	100
8.3.6 Process Variable Data Transmission Format (BINARY)....	86	11.1 Common Specifications	100
8.4 Outputting the Unit and Decimal Point Position Data	87	11.1.1 Input Signal.....	100
8.4.1 Specifying the Unit and Decimal Point Position Data Output.....	87	11.1.2 Performance and Characteristics.....	100
8.4.2 Updating the Data.....	87	11.1.3 Structure.....	101
8.4.3 Outputting the Data	87	11.1.4 Power Source.....	101
8.4.4 Data Format.....	87	11.1.5 Normal Operating Conditions	101
8.5 Outputting the Status.....	88	11.1.6 Alarm (Relay Output is Optional).....	102
8.5.1 Status Output Command	88	11.1.7 Safety Standard and EMI Standard.....	102
8.5.2 Status Output.....	88	11.1.8 DI Function (Option).....	102
8.6 Data Reception Example.....	89	11.1.9 Paper-empty Detecting Function (Option).....	102
9. MAINTENANCE.....	90	11.2 Standard Setting Specifications	103
9.1 Inspection.....	90	11.2.1 Measurement Range.....	103
9.2 Cleaning.....	90	11.2.2 The Accuracy at the Computation.....	106
9.3 Replacing Consumables.....	91	(1) Scaling	106
9.4 Adjust Dot Printing Position (Point Calibration).....	91	(2) Square root computation	106
9.5 Calibration (Data Calibration).....	91	(3) Decade	107
(1) Calibration of Voltage.....	92	(4) Difference, Sum, and Average	107
(2) Calibration of Resistance temperature detector.....	92	11.2.3 Individual Specifications	108
(3) Calibration of Reference Junction Compensation	93	11.2.4 Standard Functions	109
		11.3 Standard Setting Functions.....	110
		11.3.1 Standard Setting Functions	110
		11.4 Optional Functions	110
		11.4.1 Remote Function of DI.....	110
		11.4.2 Alarm Board.....	110
		11.4.3 Communication unit	110

Addendums:

Page 111: Adding Relay Output Option

Page 114: Out of Paper Option - Configuring Relay Output #1

Page 115: Future Design Controls CR06 Warranty

1. INTRODUCTION

1.1 Checking the Accessories

Upon delivery of this instrument, unpack and check its accessories and appearance.

If there are any missing accessories or damages on the appearance, contact our dealer where you purchased the instrument, or our sales representative.

Following accessories should be attached.

① Chart paper

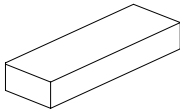

② Ribbon cassette

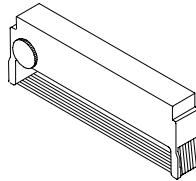

③ Mounting bracket

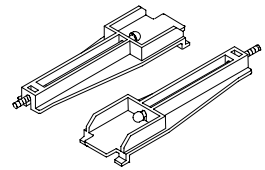

④ Instruction manual

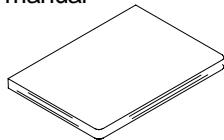

⑤ Packing

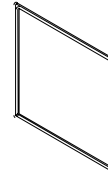

Fig. 1.1 Accessories

Table 1.1 List of Accessories

No.	Part Name	Type	Quantity	Remarks
1	Chart paper	HZCGA0105EL001	1	50 equal divisions
2	Ribbon Cassette	WPSR188A000001A	1	
3	Mounting bracket	H4A14175	2	Panel mounting bracket
4	Instruction manual	MANUAL CR06	1	This manual
5	Packing	H4H14900	1	For IP65

[Note]

• The ribbon cassette has been set in the instrument upon shipment.

1.2 Checking the Type and Specifications

A nameplate is affixed to the inside of the instrument. Remove the chart holder and make sure that the nameplate is affixed to the middle far side of the instrument.

Make sure that this instrument meets your requested specification, seeing the following tables.

Table 1.2 Type

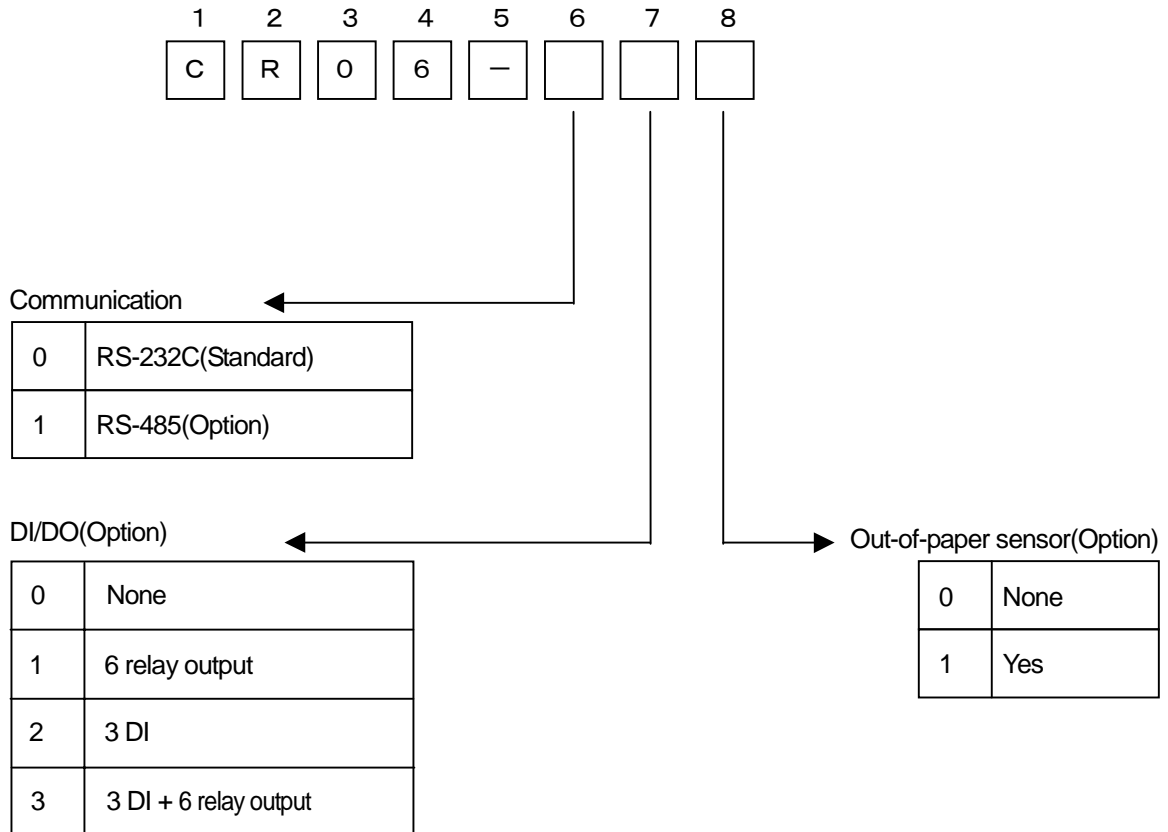

1.3 Temporary Storage

Store the instrument in the following environment.

When incorporated in the equipment, store it in the following environment as well.



CAUTION

- Storage in a poor environment may damage the appearance, functions, and service life of the instrument.
-
- Storage Environment
 - •A place with little dust.
 - •A place free from combustible, explosive, or corrosive gases (SO₂, H₂S, etc.).
 - •A place free from vibrations or shocks.
 - •A place free from water or steam or high humidity (95% RH max.).
 - •A place free from direct sunshine or high temperature (50°C max.).

1.4 Indication Card

An indication card has been affixed to the door upon delivery. Enter a name as required.



CAUTION

- Note that if a non-original nameplate is attached, it may damage the door or mounting part.

2. CONSTRUCTION

2.1 Appearance

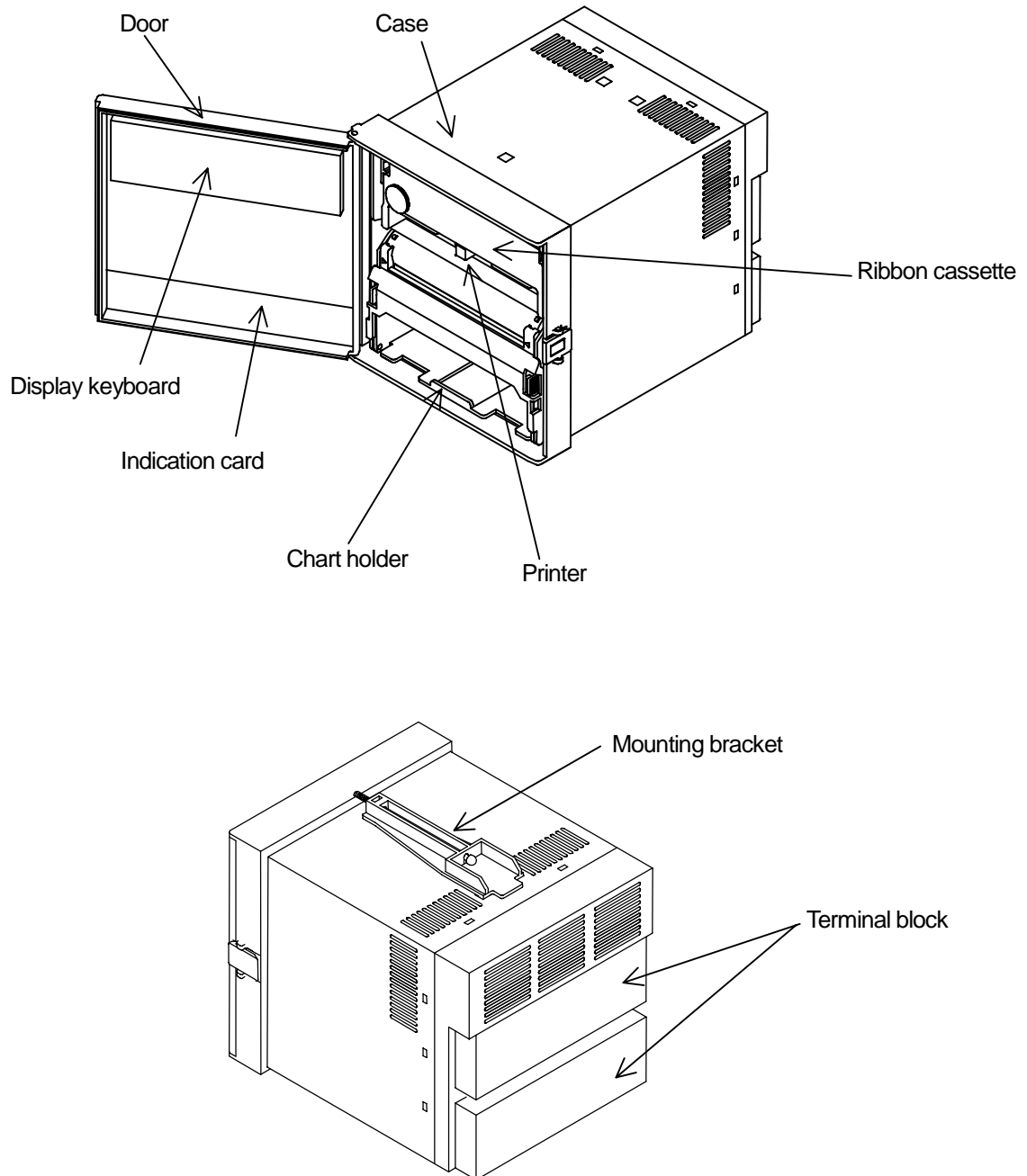

Fig. 2.1 Appearance

2.2 Display Screen and Operation Keys

2.2.1 Display Screen

The following describes the display screen. Since the channel numbers and data are indicated by a 7-segment LED, alphabets are symbolized to represent them.

For the LED display, see "Symbolized Alphabets for Display" at [Reference] below.

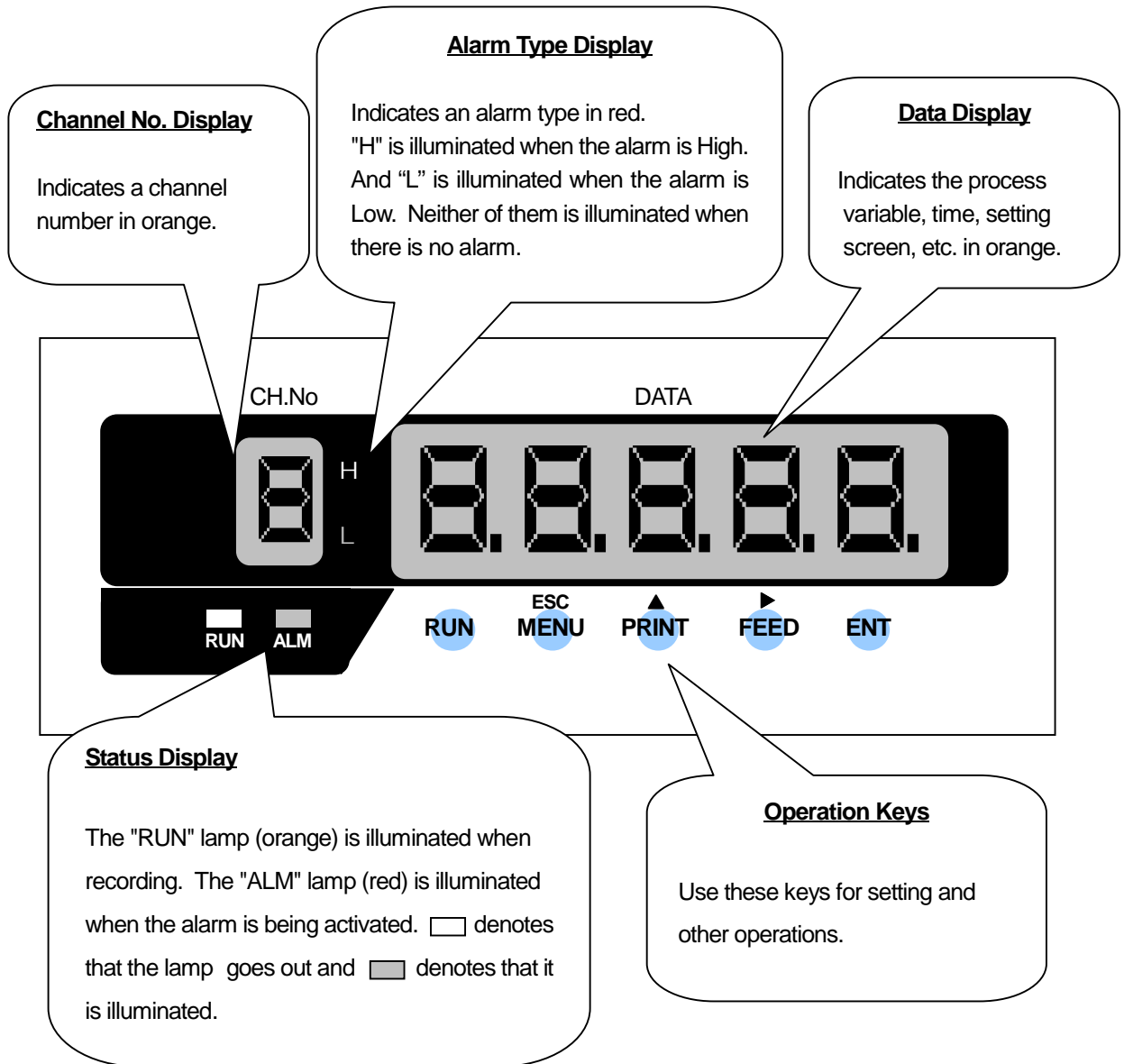

Fig. 2.2 Display

[Reference] Symbolized Alphabets for Display

Display	A	b	C	d	E	F	G	H	h	I	J	K	L	l
Alphabet	A	B	C	D	E	F	G	H	h	I	J	K	L	l
Display	M	N	O	P	q	r	S	t	U	V	W	X	Y	Z
Alphabet	M	N	O	P	Q	R	S	T	U	V	W	X	Y	Z

2.2.2 Operation Keys

The following describes each operation key.

This manual represents the actual operation keys as shown in the figure below.

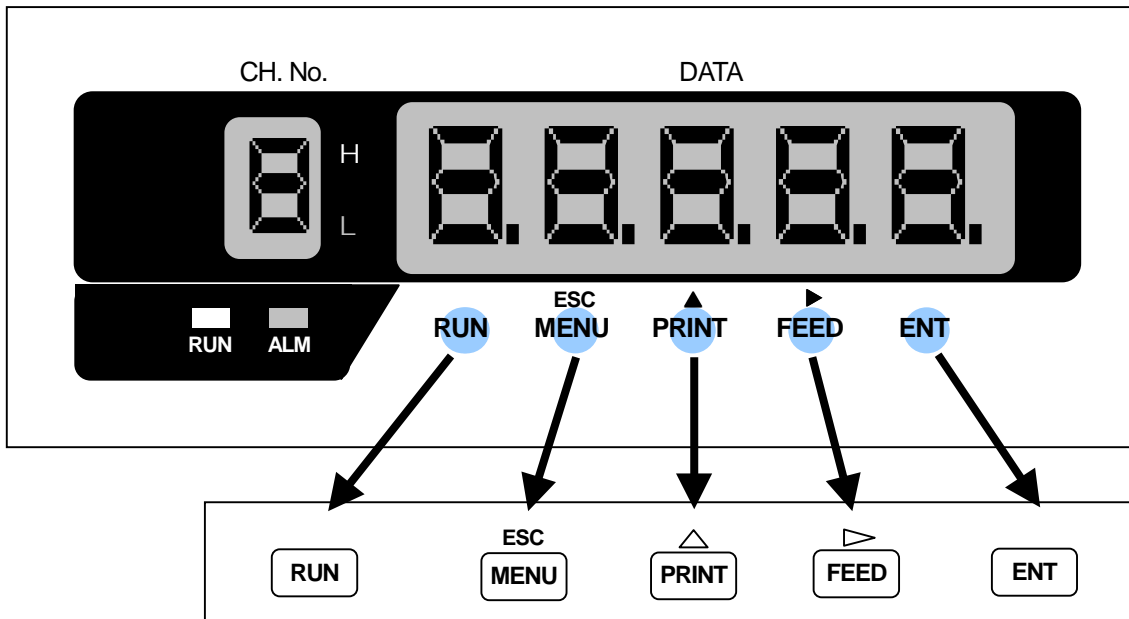

Fig.2.3 Actual Display and Operation Keys

Table2.1 Names of Operation Keys and Their Functions

Key	Name	Function	
	"RUN" key	Starts/stops recording. To stop, hold down the "RUN" key for 3 seconds or more. (Gone out the "RUN" lamp.) To start, press the "RUN" key. (Illuminates the "RUN" lamp.)	
	"MENU" key	MENU function	Selects engineering list print and change to the setting mode.
	"ESC" key	ESC function	Exits that menu halfway selecting a function.
	"PRINT" key	PRINT function	Used to perform manual print or list print.
	"Δ" key	Δ function	Used to select a setting parameter (numeral or built-in command)(ascending direction).
	"FEED" key	FEED function	The chart paper is fed while the key is pressed, and stopped when released.
	"▷" key	▷ function	Used to shift a digit in setting a numeral.
	"ENT" key	Used for registering a setting parameter (numeral or built-in command) after selecting it, or executing a function. Pressing this key executes the setting.	

3. INSTALLATION

3.1 Outside Dimensions Drawing and Panel Cutting Dimensions

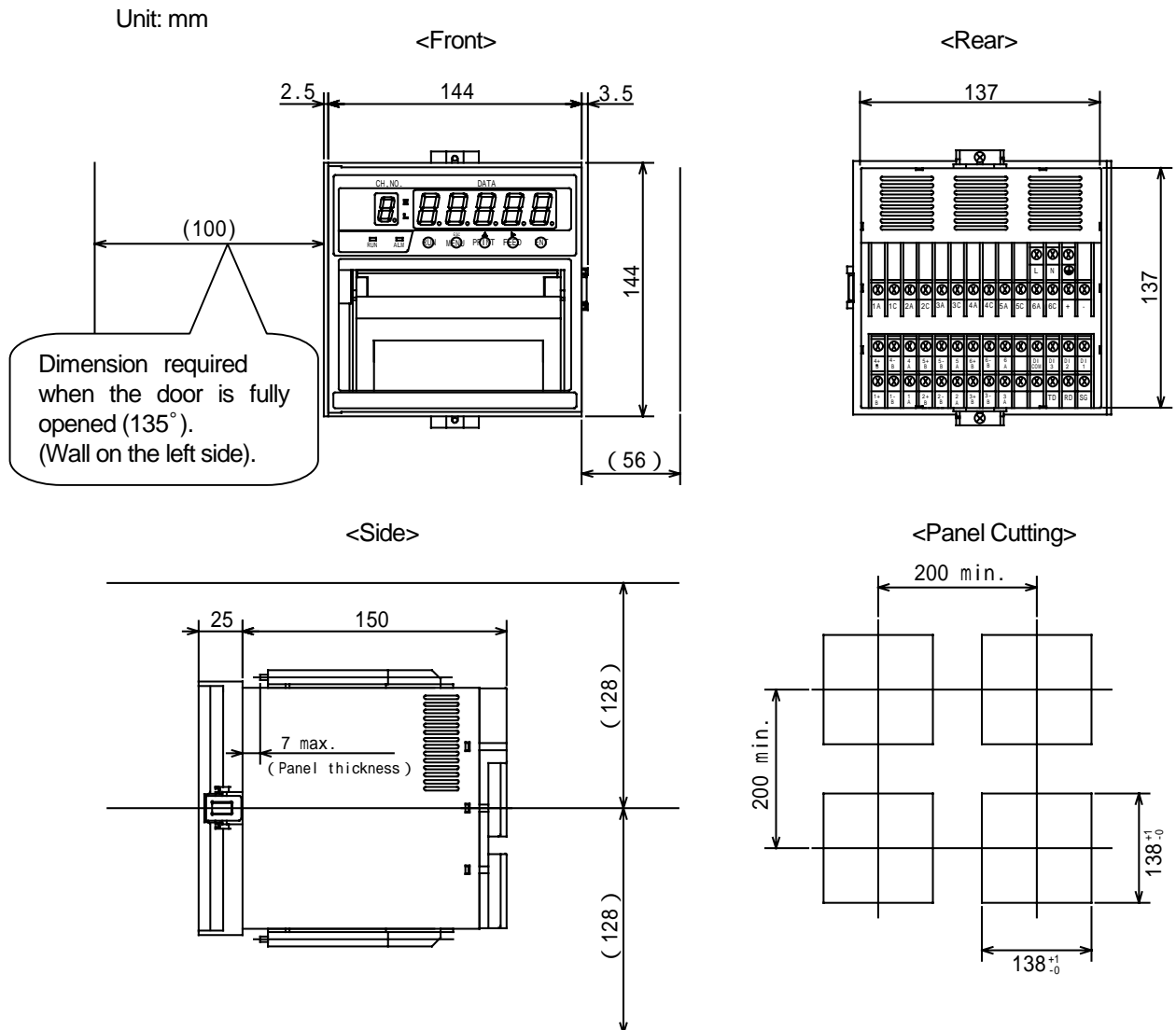

Fig.3.1 Outside Dimensions and Panel Cutting Dimensions



CAUTION

- For maintenance and safety of the instrument, it is recommended to secure the spacing larger than the parenthesized dimensions per unit.

3.2 Mounting to the Panel



WARNING

- Do not install the instrument in a place exposed to a combustible, explosive, or corrosive gas (SO_2 , H_2S , etc.).



CAUTION

Install the instrument in the following places

- A place free from where humidity often changes.
- A place of normal temperature (25°C or so).
- A place exposed to as little mechanical vibrations as possible.
- A place with as little dusts as possible.
- A place affected by the electromagnetic field as little as possible.
- A place not directly exposed to high radiant heat.
- A place where the altitude is up to 2000m.
- Humidity has an effect on the chart paper and ink. Use the instrument in a humidity range of 20 to 80%RH (60%RH is optimum).
- This instrument needs the inside installation.

Mounting to the Panel

- A steel plate not thinner than 1.2mm is recommended as a mounting panel.
- The maximum thickness of the mounting panel is 7mm.

Inclination

- Install the instrument horizontally.
- The instrument should be installed so that its inclination should be 0° at the front and within 30° at the rear.

3.2.1 Procedure for Mounting to the Panel

- 1) Assemble the mounting bracket refer to Fig.3.2.
- 2) Fit in this instrument through the front of the panel.
- 3) Fit the claws of the mounting bracket into the square holes in the top and bottom surfaces of the case.
- 4) Tighten the screw of the mounting bracket with a screwdriver to attach it to the panel. When the mounting unit does not move back and forth any more, tighten a screw by 180° .

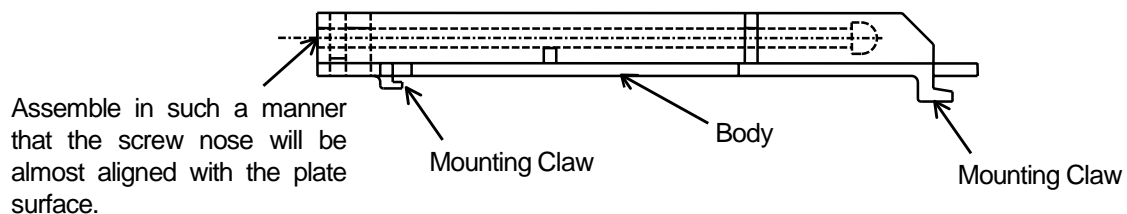

Fig.3.2 Mounting bracket

[Note]

- If it is tightened with an excessive force, the case may be distorted and the mounting bracket may be deformed. An adequate tightening torque is about 0.2 to $0.3 \text{ N}\cdot\text{m}$ ($2\sim 3 \text{ kgf}\cdot\text{cm}$).

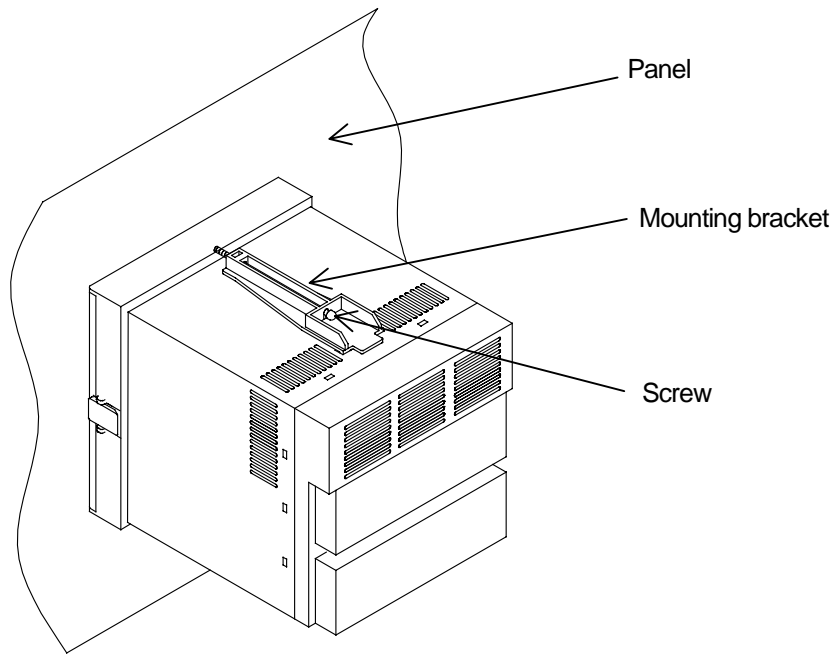

Fig.3.3 Mounting to the Panel

3.2.2 Mounting to the Panel in compliance with the IP65

Prior to mounting the instrument to the panel, attach a packing to the position shown in the figure.
The rest of the procedure is the same.

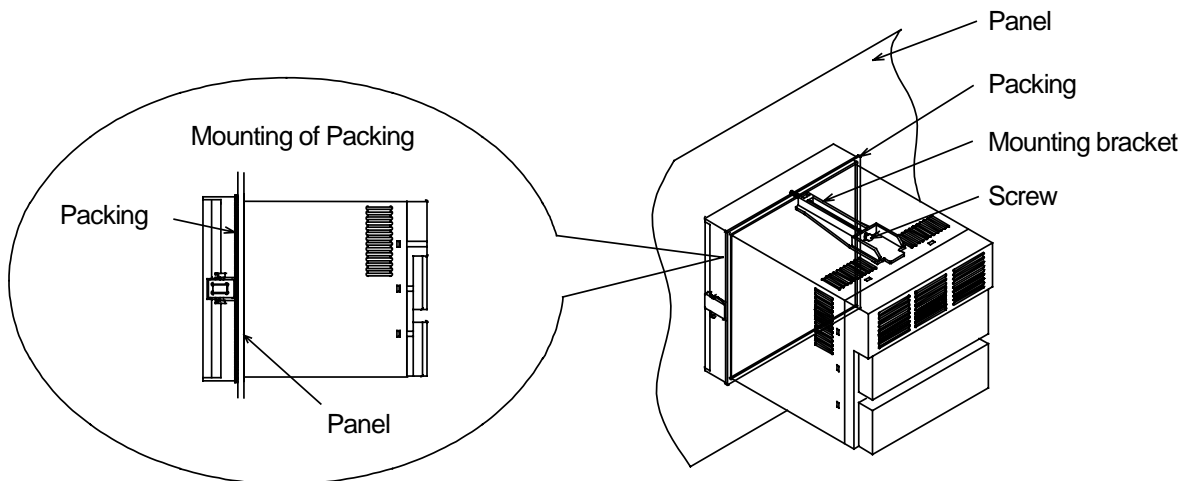

Fig.3.4 Mounting to the Panel (in compliance with the IP65)

4.1 Terminal Layout and Power Wiring

4.1.1 Terminal Layout

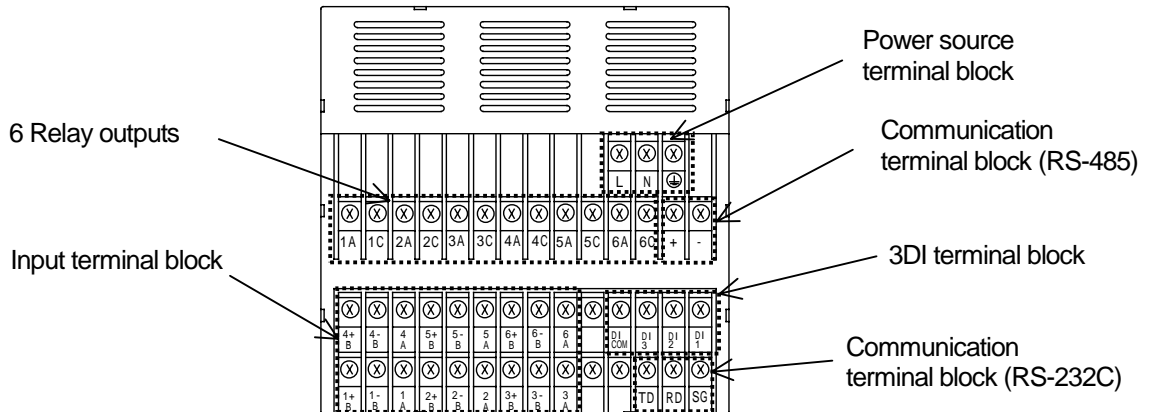

Fig. 4.1 Terminal Layout (Rear view)

4.1.2 Power Wiring



WARNING

- ① In order to prevent an electric shock, be sure to provide protective grounding prior to turning on the instrument.
- ② Do not cut a protective grounding conductor or disconnect protective grounding.
- ③ Make sure that the supply voltage for the instrument conforms to the voltage of the supply source.
- ④ Attach a transparent protective cover prior to turning on the POWER of the instrument.
- ⑤ Any interruption of the protective conductor inside or outside the apparatus or disconnection of the protective grounding terminal is likely to make the apparatus dangerous under some fault conditions. Intentional interruption is prohibited.



CAUTION

- ① As an electric wire for the power source, use a 600 V vinyl insulated wire (IEC 227-3) or its equivalent or above.
- ② Attach a round press-fitting terminal with insulated sleeve (for M3.5) to the end of the electric wire.
- ③ Connect a protective grounding (resistance:100Ω or lower, a minimum diameter of a grounding conductor:1.6mm) to the protective grounding terminal.
- ④ If other instrument shares the protective grounding conductor, there may be an effect caused by noise coming from the grounding conductor. It is recommended not to share it with other instrument.
- ⑤ In order to comply with the requirements of safety standard EN61010, the recorder shall have one of the following as a disconnecting device, fitted within easy reach of the operator, and labeled as the disconnecting device.
 - a. A switch or circuit breaker which complies with the requirements of IEC60947-1, IEC60947-2 and IEC60947-3.
 - b. A separable coupler which can be disconnected without the use of a tool.
 - c. A separable plug, without a locking device, to mate with a socket outlet in the building.
- ⑥ This product has designed to conform to IEC1010-1 installation Category II and pollution degree 2.

4.1.3 Wiring Procedure



CAUTION

The transparent protective cover should surely remove the left and right (both sides) hooks simultaneously. If it removes by turns, there is a possibility that it may damage.

- 1) Put your fingers on the left and right (both sides) hooks of the transparent protective cover on the power source terminal block. Pushing them inside, take out the cover to this side.
- 2) Connect the power source electric wire refer to Fig. 4.2. Connect the protective grounding to the  terminal. Connect the non-grounding side of the power source to "L" terminal. Connect the grounding side to the "N" terminal.
- 3) Put back the transparent protective cover.
- 4) Make sure that protective grounding is properly provided.

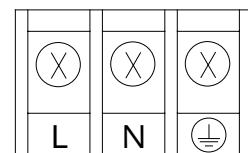

Fig. 4.2 Power source Terminal block

4.2 Input Wiring



CAUTION

① Precautions for the input electric wire

- See that no noise is mixed in input wiring. For input wiring, it is recommended to use a shielding wire or twisted wire effective for noise.
- In case of thermocouple input, connect a thermocouple wire directly or use a compensating lead wire. It is recommended to use a shielded input line.
- In case of resistance temperature detector input, dispersion of 3-wire line resistance should be less than the below mentioned values. It is recommended to use a shielded input line.
For Pt 100, JPt 100 ; 50m Ω max.
- When it is likely to be affected by induction noise, particularly when wiring near the high-frequency power source, it is recommended to use a shielded twisted wire.
- Attach a round press-fitting terminal with insulated sleeve (for M3.5) to the end of the electric wire.

② Precautions for wiring

- The wiring between the instrument and measurement point should be kept away from the power circuit (25V or higher circuit or DO circuit).
- Short-circuit unused input terminals. (Short-circuit between "+" and "-" in case of mV, V, or thermocouple input, and short-circuit among A, B, and B in case of resistance temperature detector input.)
- Ground the shield of connecting wire.

4.2.1 Wiring Procedure



CAUTION

The transparent protective cover should surely remove the left and right (both sides) hooks simultaneously. If it removes by turns, there is a possibility that it may damage.

- 1) Put your fingers on the left and right (both sides) hooks of the transparent protective cover on the input terminal block. Pushing them inside, take out the cover to this side.
- 2) Wire the input lines refer to Fig. 4.3(Page 18), Fig. 4.4 and Fig. 4.5.(Page 19)
- 3) Put back the transparent protective cover.

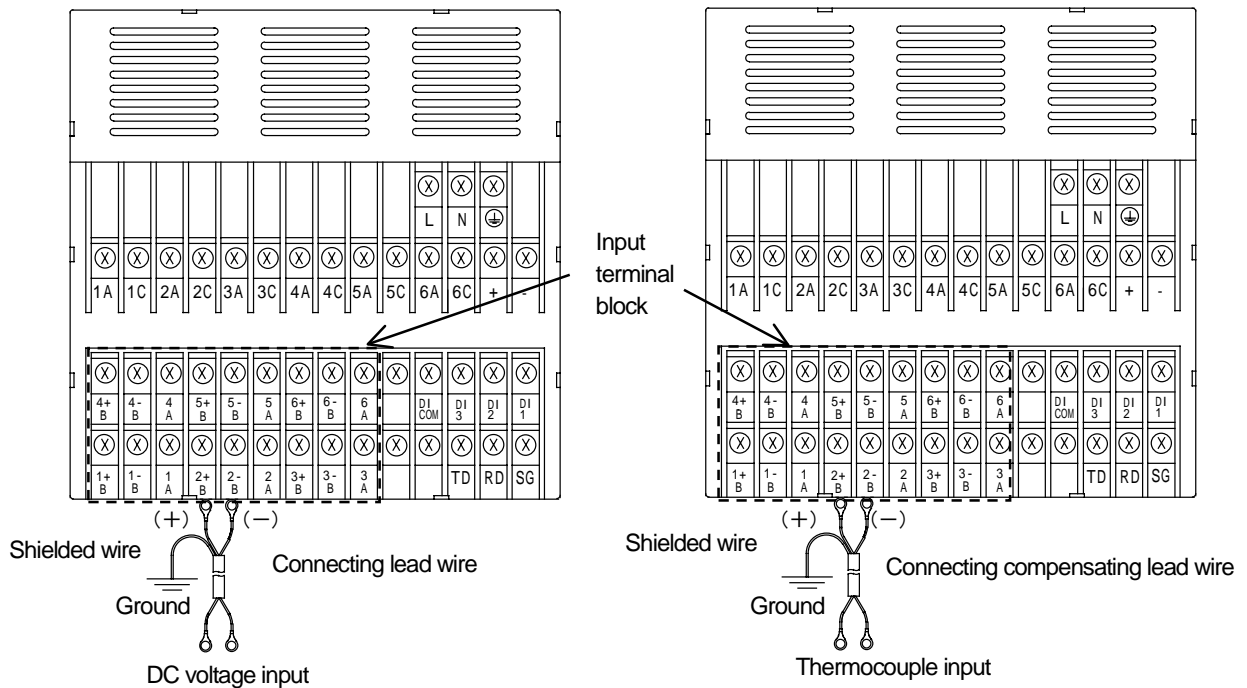

Fig. 4.3 Input Wiring (For mV, V and Thermocouple inputs)

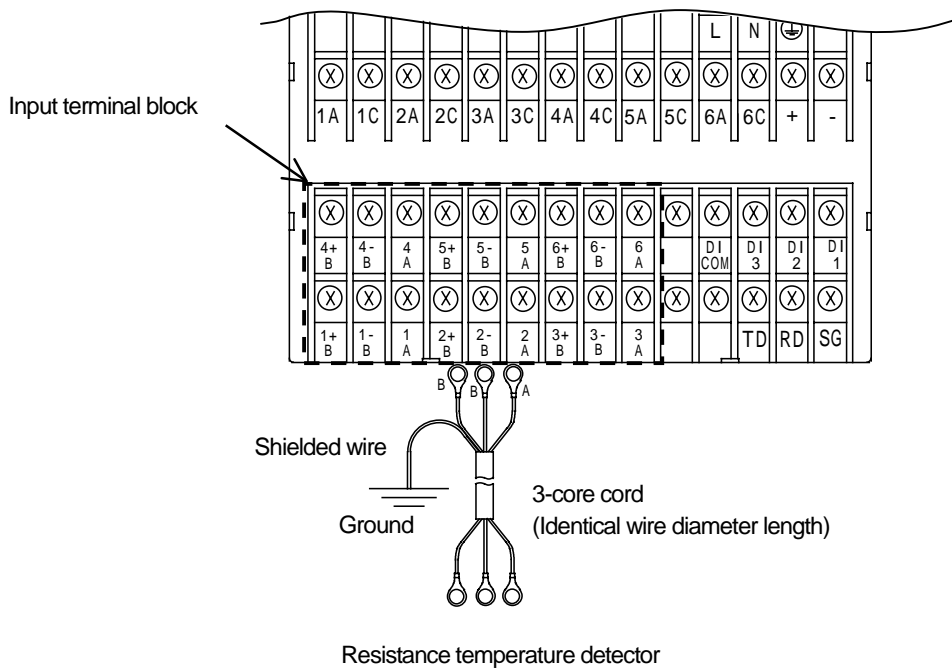

Fig. 4.4 Input Wiring (For Resistance temperature detector)

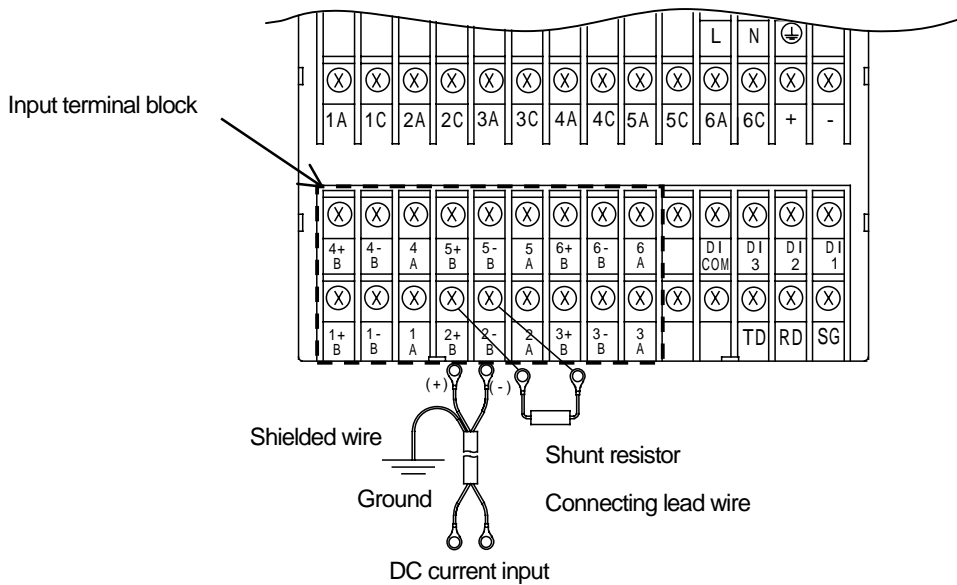

Fig. 4.5 Input Wiring (For mA input)



CAUTION

- ① Attach the shunt resistor to the input terminal block of the instrument.
- ② Input accuracy is effected with the shunt resistor. Use the following recommended resistor.
Resistance: 250 Ω, Rated power: 1/4W, Tolerance: ±0.1% max.
Temperature coefficient: ±50ppm max.

4.3 DI/Alarm Output Wiring (Option)



WARNING

- ① Be sure to wire after turning off the POWER.
- ② When the power source has been connected to the Alarm output, turn off that power source.
- ③ When a hazardous voltage supplies to alarm terminal:
 - a) Never touch terminals preventing from electric shock.
 - b) Attach covers to terminals.
 - c) Wires should be double shielded.
 - d) Adopts round pressure terminal connectors with insulation cover for wire, preventing from lose connection.



CAUTION

Precautions for Wiring the DI

- ① DI input has the built-in drive power source. Do not apply a voltage to a DI input terminal from the outside.
- ② A DI input contact capacity should be a withstand voltage of 50V DC, 16mA or more, ON resistance of 20Ω max.(Wiring resistance included).
- ③ Do not use unused terminals as relay terminals.

Precautions for Wiring the Alarm Output

- ① An alarm output contact capacity is as follows :

250VAC :	3A at maximum (Resistive load)
30VDC :	3A at maximum (Resistive load)
125VDC :	0.5A at maximum (Resistive load)
	0.1A at maximum L/R= 7ms at maximum (Inductive load)
- ② Attach an anti-surge protective circuit (surge absorbers, etc.) to an output terminal, as required.
- ③ Attach a round press-fitting terminal with insulated sleeve (for M3.5) to the end of an electric wire.
- ④ Keep alarm output wiring away from input wiring.
- ⑤ Do not use unused terminals as relay terminals.

4.3.1 DI/Alarm Output Wiring Example

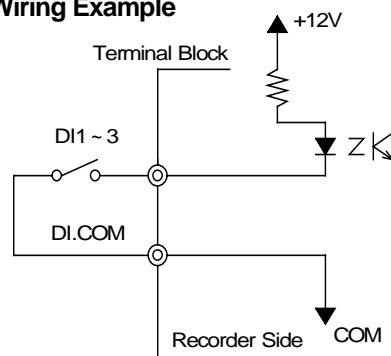

Fig. 4.6 DI Wiring Example

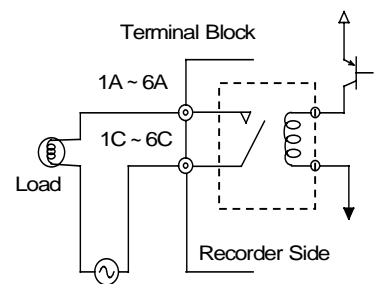

Fig. 4.7 Alarm Output Wiring Example



CAUTION

The DI (Option) consists of a combination of 3 Digital inputs. The alarm output consists of 6-Relay output (Normally open).

4.3.2 Alarm Output Wiring Procedure

Wire the Alarm output refer to Fig.4.8.

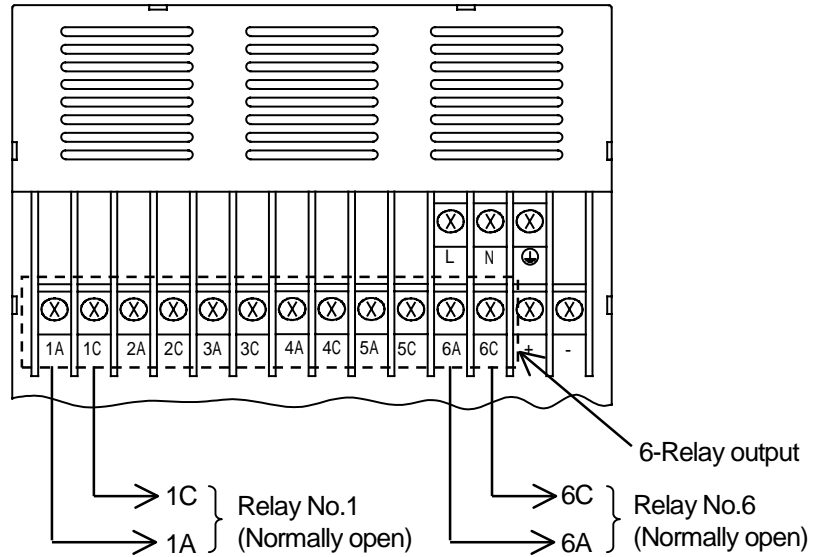
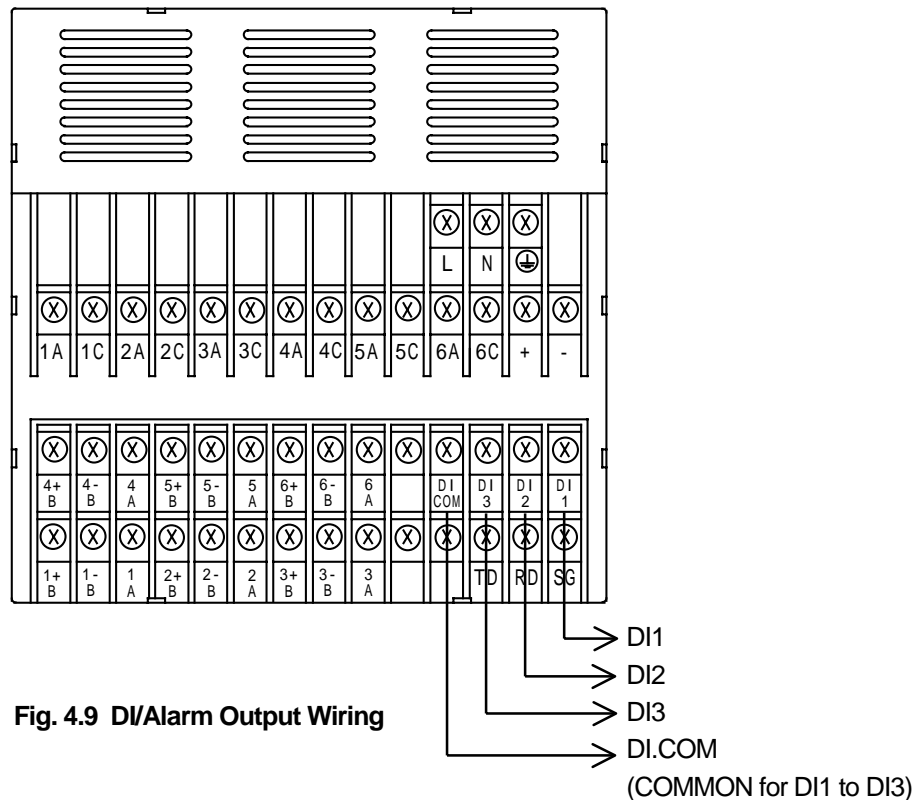

Fig. 4.8 Alarm Output Wiring

4.3.3 DI Wiring Procedure

Wire the DI refer to Fig.4.9.



4.4 Communication Wiring



CAUTION

Precautions for the communication wiring

- ① See that no noise is mixed in communication wiring. For communication wiring, it is recommended to use a shielding wire effective for noise.
- ② When it is likely to be affected by induction noise, particularly when wiring near the high-frequency power source, it is recommended to use a shielded twisted wire.
- ③ Attach a round press-fitting terminal with insulated sleeve (for M3.5) to the end of the electric wire.
- ④ Ground the shield of a connecting wire.

4.4.1 RS-232C Wiring

Wire RS-232C refer to Fig.4.10.

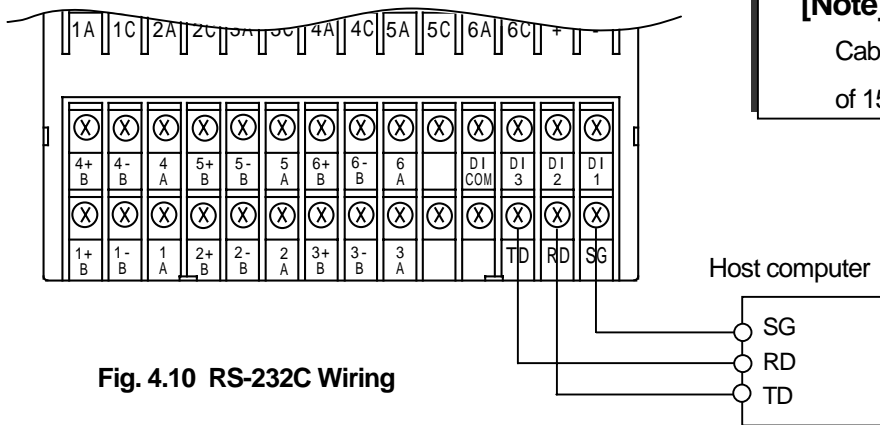

Fig. 4.10 RS-232C Wiring

[Note]

Cable length is a maximum of 15m.

4.4.2 RS-485 Wiring

Wire RS-485 refer to Fig.4.11.

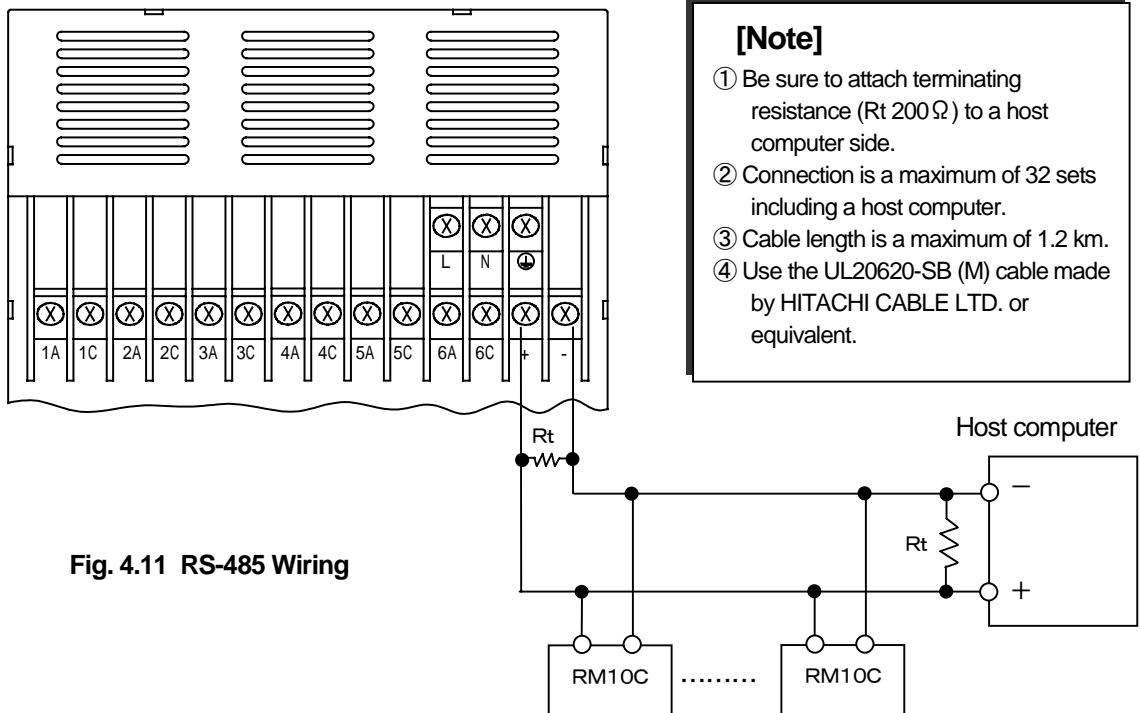

Fig. 4.11 RS-485 Wiring

[Note]

- ① Be sure to attach terminating resistance (R_t 200 Ω) to a host computer side.
- ② Connection is a maximum of 32 sets including a host computer.
- ③ Cable length is a maximum of 1.2 km.
- ④ Use the UL20620-SB (M) cable made by HITACHI CABLE LTD. or equivalent.

5. PREPARATIONS FOR OPERATION

5.1 Setting the Chart Paper

CAUTION

It is recommended to use our original chart paper to ensure proper recording. If the chart paper holder is taken out with recording operation being activated, the ink ribbon may be damaged. To replace the chart paper, be sure to press the “RUN” key to stop recording.

(1) Pressing the “RUN” key for 3 seconds or more

Stop recording operation. With the power turned on, press the “RUN” key for 3 seconds or more.

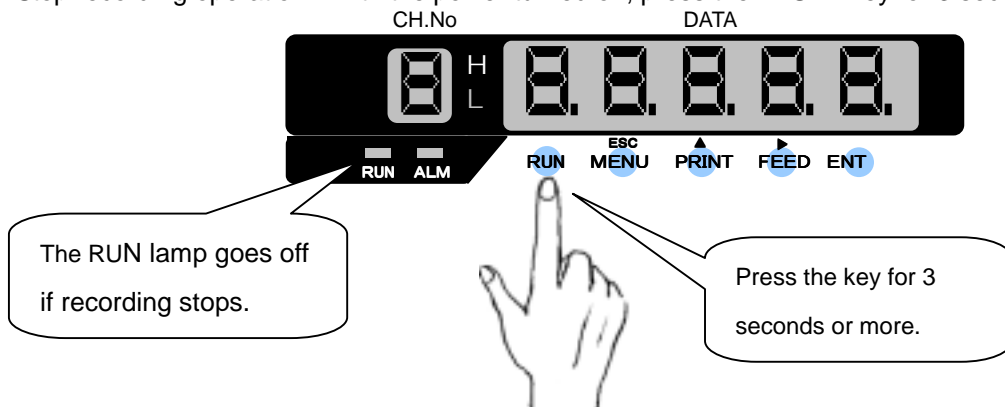

Fig. 5.1 Pressing the “RUN” key

(2) Opening the Door

CAUTION

Maximum angle of the door in opened-state is 135 degree. Do not further open the door otherwise hinge will be broken.

Push the door hook to unlock the door. Pull the door to this side to open it.

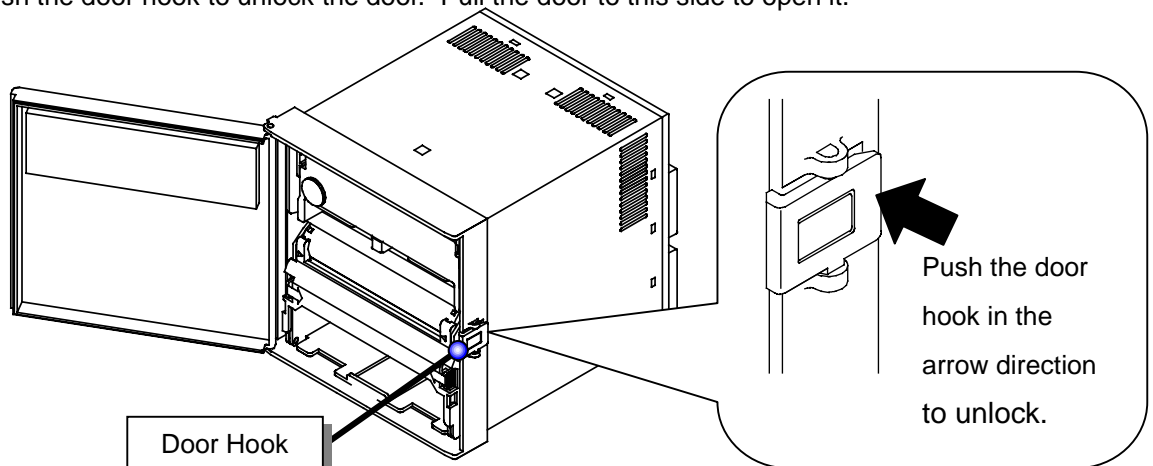

Fig. 5.2 Opening the Door

(3) Taking out the Chart Holder

Put your fingers onto the levers at both sides of the chart holder and pull it out to this side.

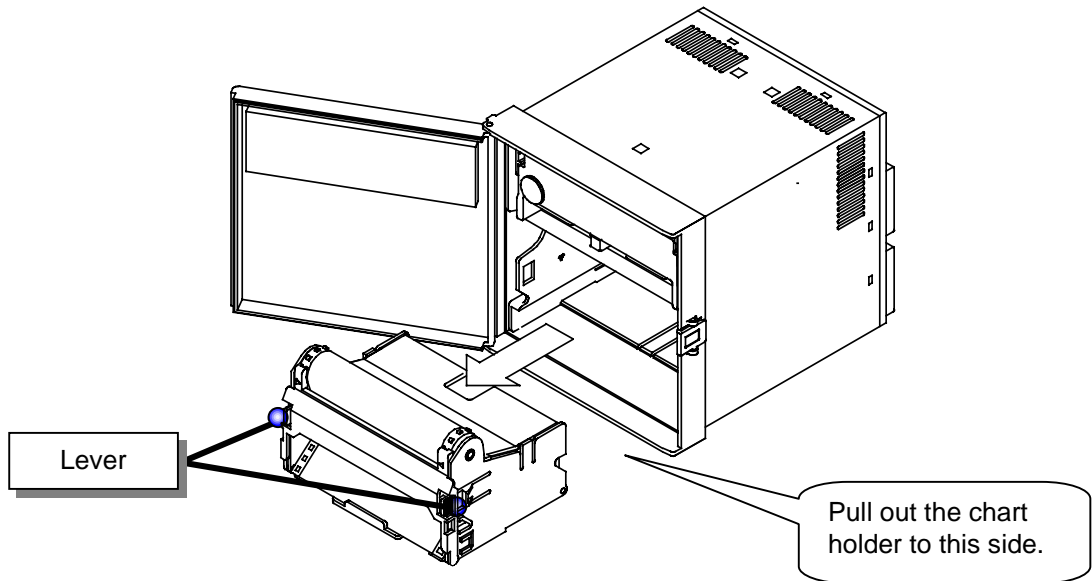

Fig. 5.3 Taking out the Chart Holder

(4) Opening the Chart Cover and Chart Guide

Open the chart guide and the chart cover outwardly.

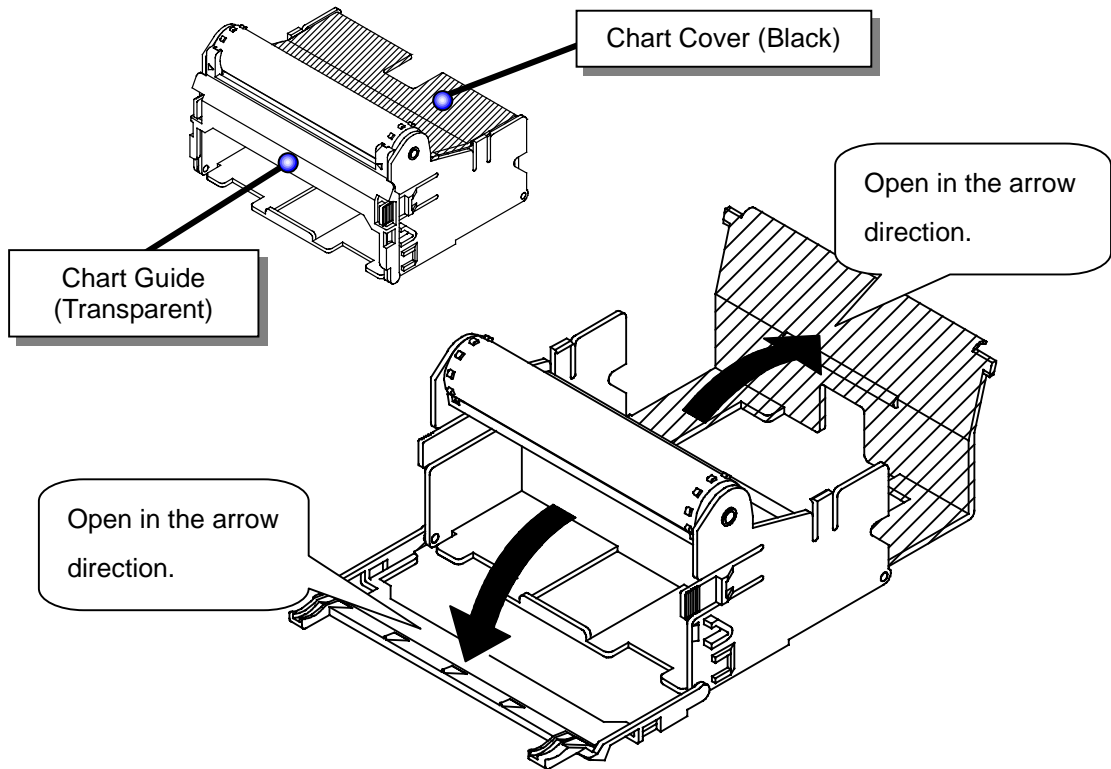

Fig. 5.4 Opening the Chart Cover and Chart Guide

(5) Loosening the chart paper

The chart paper may not be proper fed, if it is stuck at perforations. Be sure to loosen the paper.

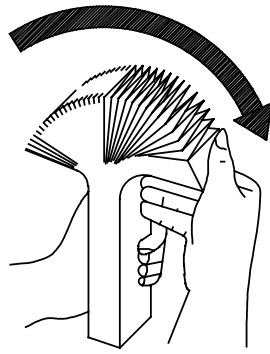

Fig. 5.5 Loosening the Chart Paper

(6) Setting the Chart Paper into the Storage Chamber

Unfold the chart paper by two plies. Holding the printing surface upward, set it in the storage chamber.

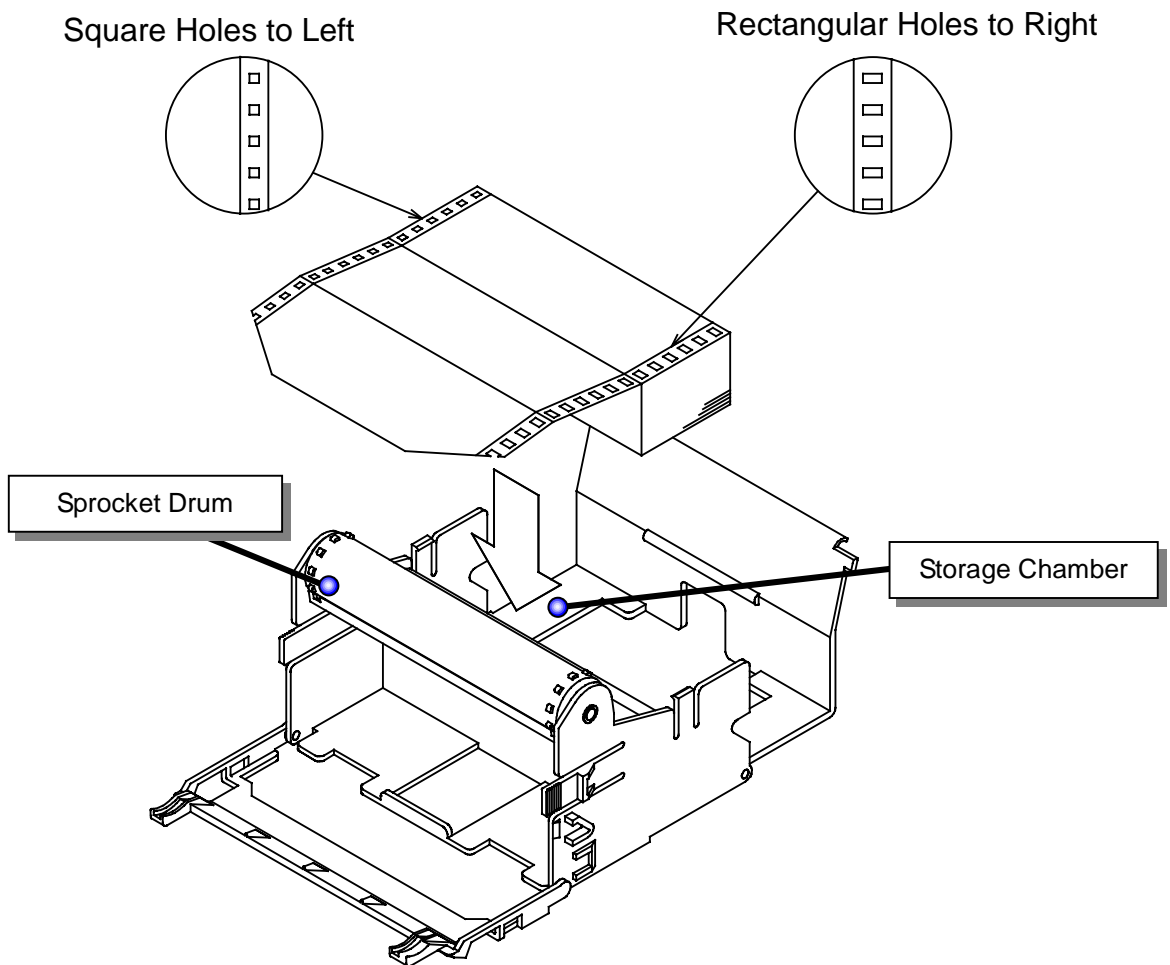

Fig. 5.6 Setting the Chart Paper

(7) Aligning the Chart Paper with the Sprocket Drum

Align the holes in the chart paper with the sprocket drum teeth. Set the chart paper along the sprocket drum. Put the first ply of the chart paper into the chart receiver.

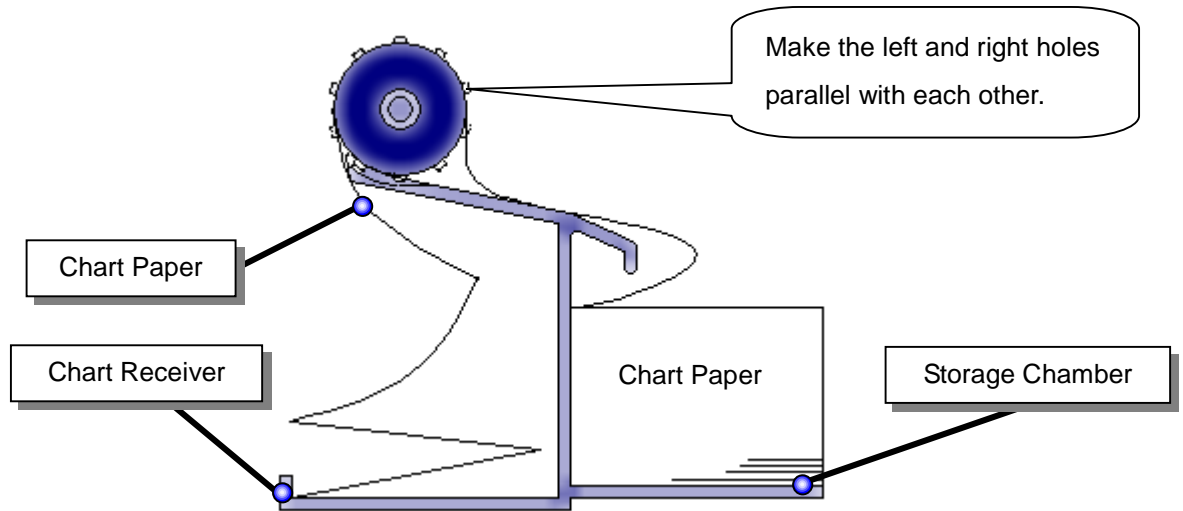

Fig. 5.7 Aligning the Chart Paper with Sprocket Drum (Chart Holder Sectional View)

(8) Closing the Chart Cover and Chart Guide

Close the chart cover and the chart guide in the arrow directions.

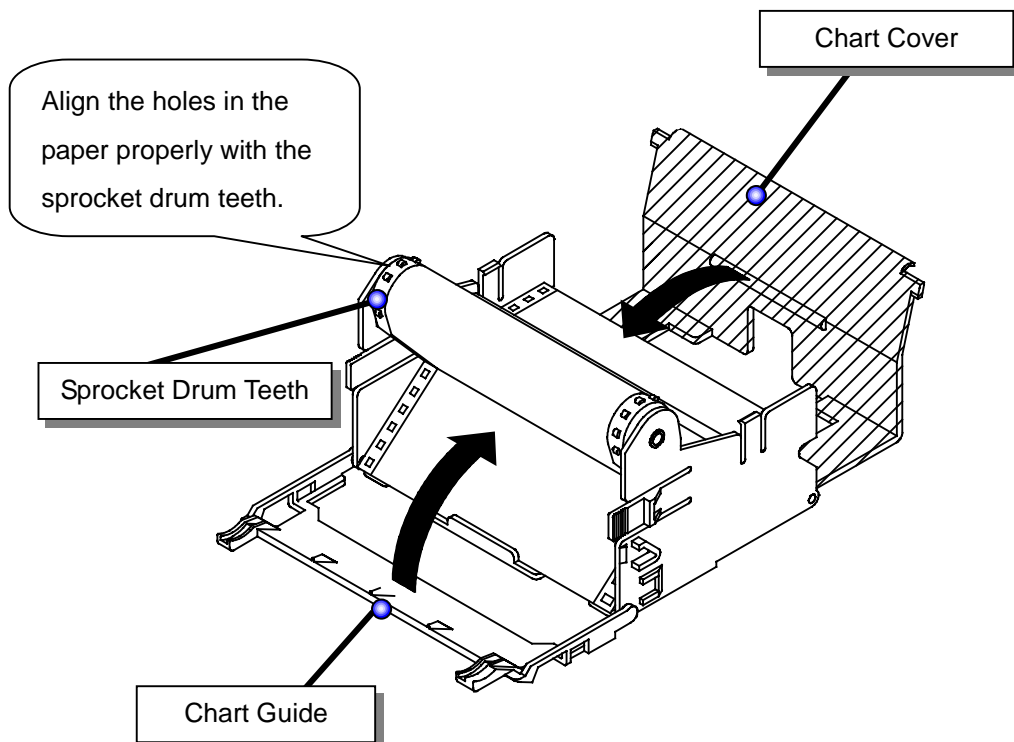

Fig. 5.8 Closing the Chart Cover and Chart Guide

(9) Turning the Sprocket Drum Gear

Check paper feed with your hand. Turn the sprocket drum gear to feed out the chart paper.
(It is recommended to feed the chart paper by 4 plies.)

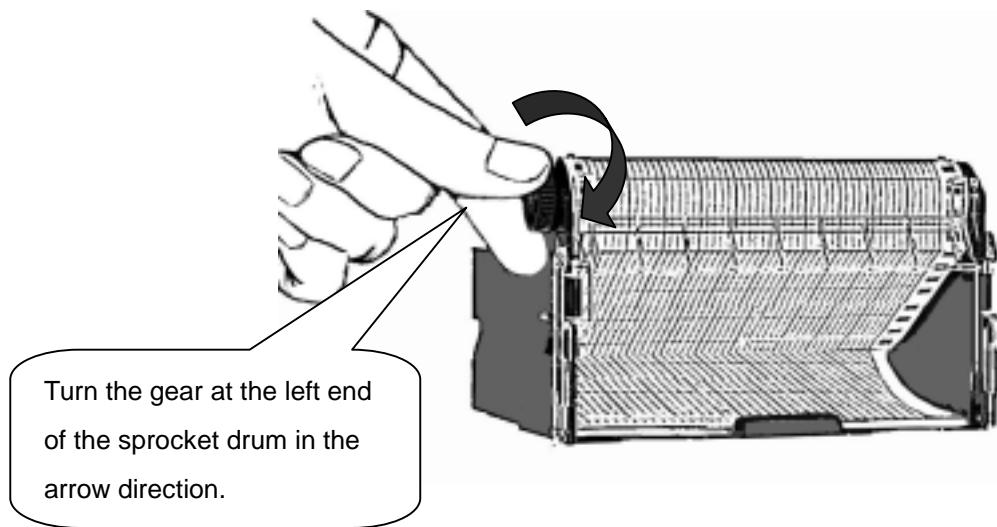

Fig. 5.9 Checking Paper Feed

(10) Putting Back the Chart Paper Holder

Push in the chart holder horizontally into the case until it is locked.

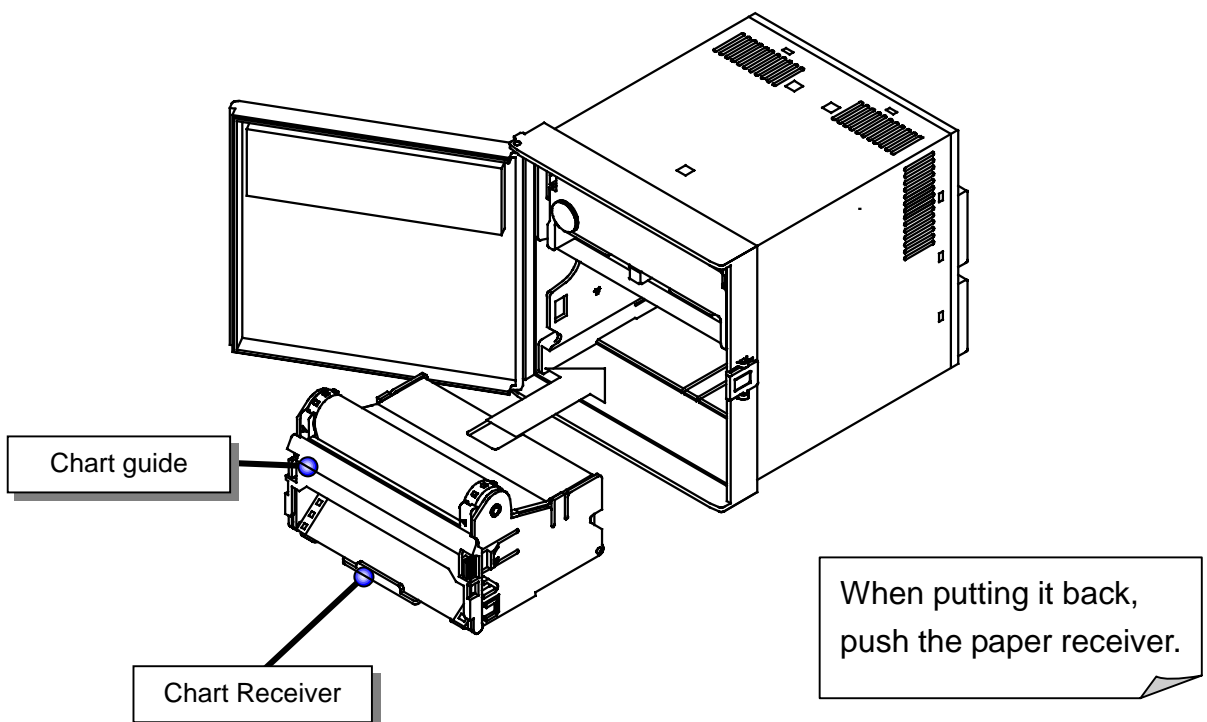

Fig. 5.10 Putting Back the Chart Holder

(11) Close the Door

Close the door and check a door lock.

(12) Pressing the “FEED” key to Check Paper Feed

Press the “FEED” key on the display keyboard to feed the chart paper.

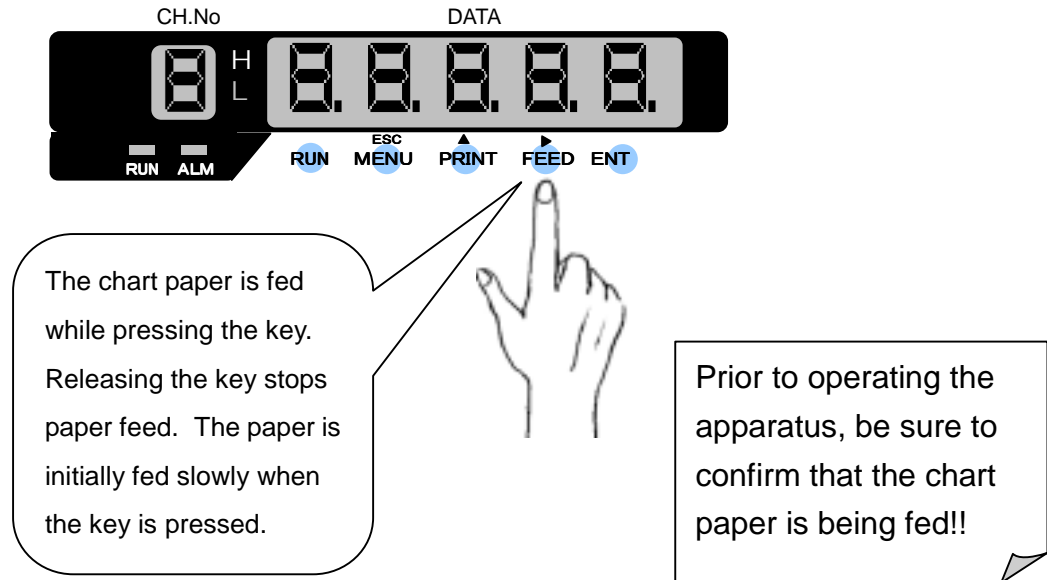

Fig. 5.11 Pressing the “FEED” key

(13) Pressing the “RUN” Key to Restart Operation

5.2 Setting the Ribbon Cassette



CAUTION

If the chart holder is taken out with recording operation being activated, the ink ribbon may be damaged. To replace the ribbon cassette, be sure to press the “RUN” key to stop recording. If the ribbon cassette is not set properly, the recording color may change or the ribbon may be damaged.

- (1) Pressing the “RUN” key for 3 seconds or more

Stop recording. With the power turned on, press the “RUN” key for 3 seconds or more.

Once recording stops, the RUN lamp goes off. (See Fig. 5.1 on page 23)

- (2) Opening the Door

Push the door hook to unlock the door. Pull the door to this side to open it.

(See Fig.5.2 on page 23)



CAUTION

Maximum angle of the door in opened-state is 135 degree. Do not further open the door otherwise hinge will be broken.

- (3) Taking out the Ribbon Cassette

Grab the left side of the ribbon cassette. Holding down the ribbon holder, take out the ribbon cassette to the front.

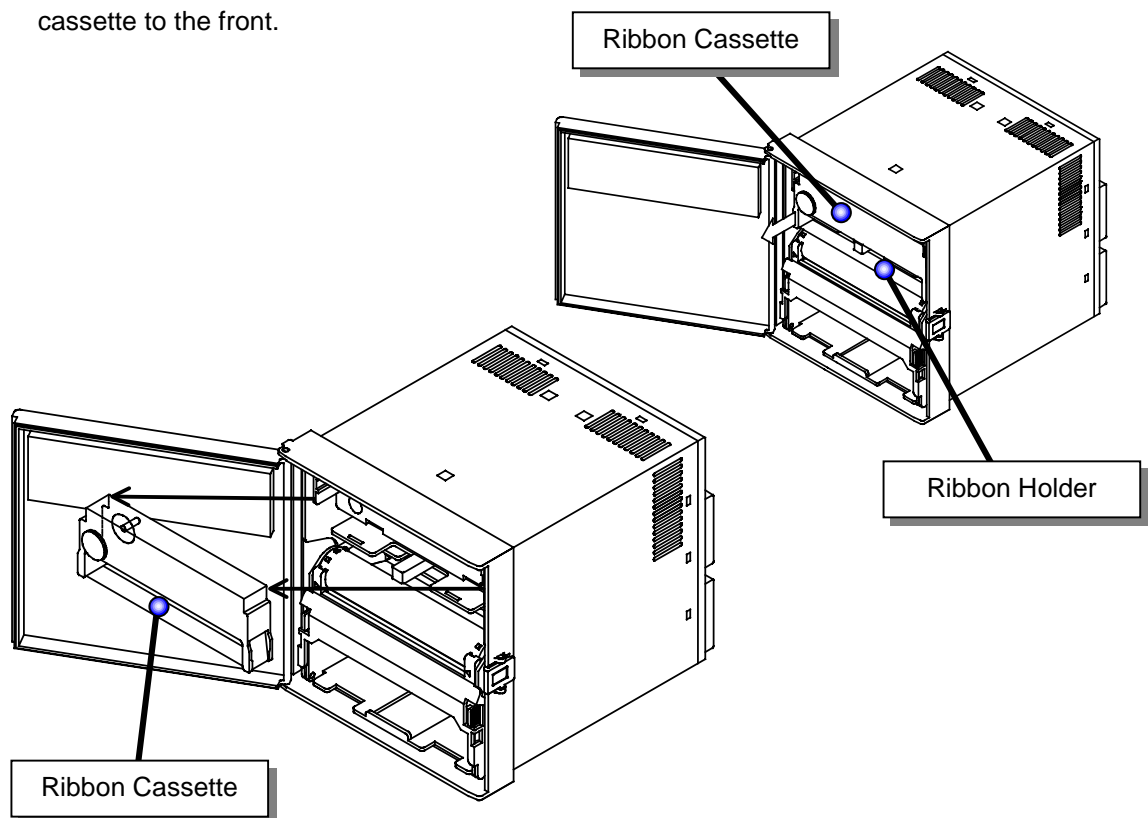

Fig. 5.12 Taking Out the Ribbon Cassette

(4) Unslacking the Ink Ribbon

Set the new ink ribbon. Turn the knob in the arrow direction to unslack the ink ribbon.

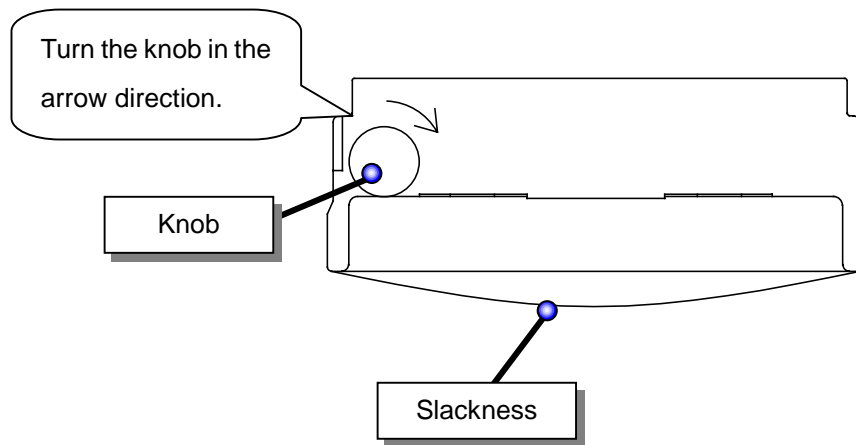

Fig. 5.13 Unslacking the Ink Ribbon

(5) Setting the Ribbon Cassette

Push the ribbon cassette into the ribbon holder until the latch clicks.

When the ribbon feed shaft is not easily fit in, turn the gear to the direction of an arrow to adjust the position. When this is done, push the ribbon cassette until the latch clicks

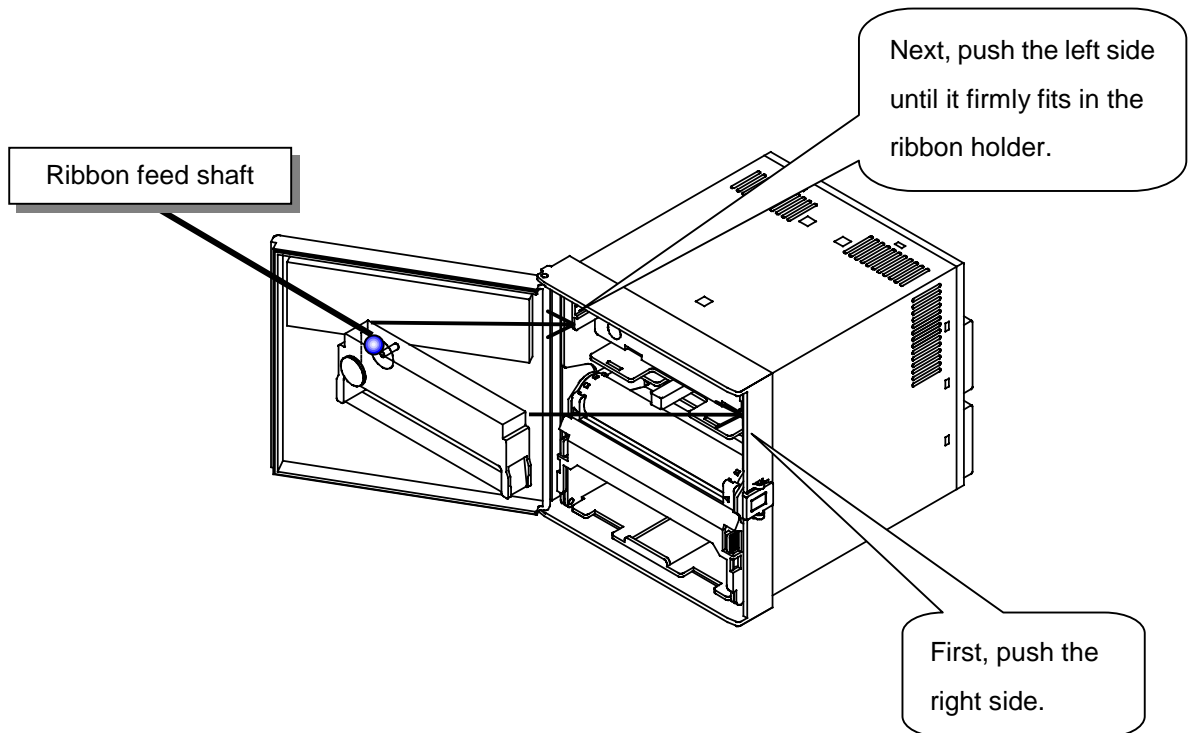

Fig. 5.14 Setting the Ribbon Cassette

6. OPERATION

6.1 Operation

WARNING

Prior to turning on the power, make sure that the supply voltage meets the specifications for the instrument and the instrument is properly grounded.

CAUTION

Prior to turning on the power, make sure that the chart paper is set in the chart holder.
If the printer is activated with no chart paper set, the sprocket drum (cylindrical part) of the chart holder may be damaged.

Once the power is turned on, the display on the front of the door is illuminated. The instrument will be ready to run (user mode) in about 5 seconds, including the initial screen. If the RUN lamp is unilluminated, press the "RUN" key to start recording operation.

6.1.1 Status after Initial Screen

- (1) Display screen :The "RUN" lamp keeps the condition of before power-off.
- (2) Printout data :All printing data and analog recording data of before power-off are cleared.
- (3) Alarm and Diagnosis :Alarm indications and outputs of before power-off are not recovered.
- (4) Data display and Channel number are displayed refer to Fig.6.1.



Fig. 6.1 Display Screen at Power-on

[Note]

- ① When electric power failure occurs, the initialization is performed after power recovery. And it becomes the above initial state.
- ② The printout data are eliminated in initialization. Printout operation is not continued after power recovery when the power is turned off during printout.
- ③ When the power is turned on, the display displays "0" while reading data in fig.6.1. The numeral of the displayed digit depends on the setting.

6.2 Recording



CAUTION

- ① The instrument checks zero point for every recording. If the printer block is manually moved during recording, a recording position may be dislocated.
- ② In order to protect the chart paper, dot printing is not performed when the distance between the previous dot printing position and the next one for an identical channel is less than 0.3 mm in the chart paper feed direction or less than 0.5 mm in the scale direction.

6.2.1 Recording Colors

Table 6.1 lists the recording colors for each channel in analog recording.

You can select a recording color from 6 colors for every channel.

Table 6.1 Recording Colors(standard)

Channel No.	Color
1	Purple
2	Red
3	Green
4	Blue
5	Brown
6	Black

6.3 How to Record

6.3.1 Starting/Stopping Recording Operation

To start/stop recording, press the “RUN” key.

To stop, hold down the “RUN” key for 3 seconds or more.

“RUN” lamp is unilluminated when step recording.

[Note]

- ① When the power is turned on, the previous state where you turned off is continued.
- ② When controlling a start/stop of recording through Digital Input (DI, option), you cannot switch start/stop with the “RUN” key.

6.3.2 Feed the Chart Paper

The chart paper is fed while the “FEED” key is pressed, and stops when released.

6.3.3 Print Sample

Logging on print example and Alarm on print example

Alarm Print:

Prints alarm occurrence/recovery, channel number, alarm type, and level. ▲ denotes alarm occurrence (in red) and ▼ denotes alarm recovery (in purple), respectively.

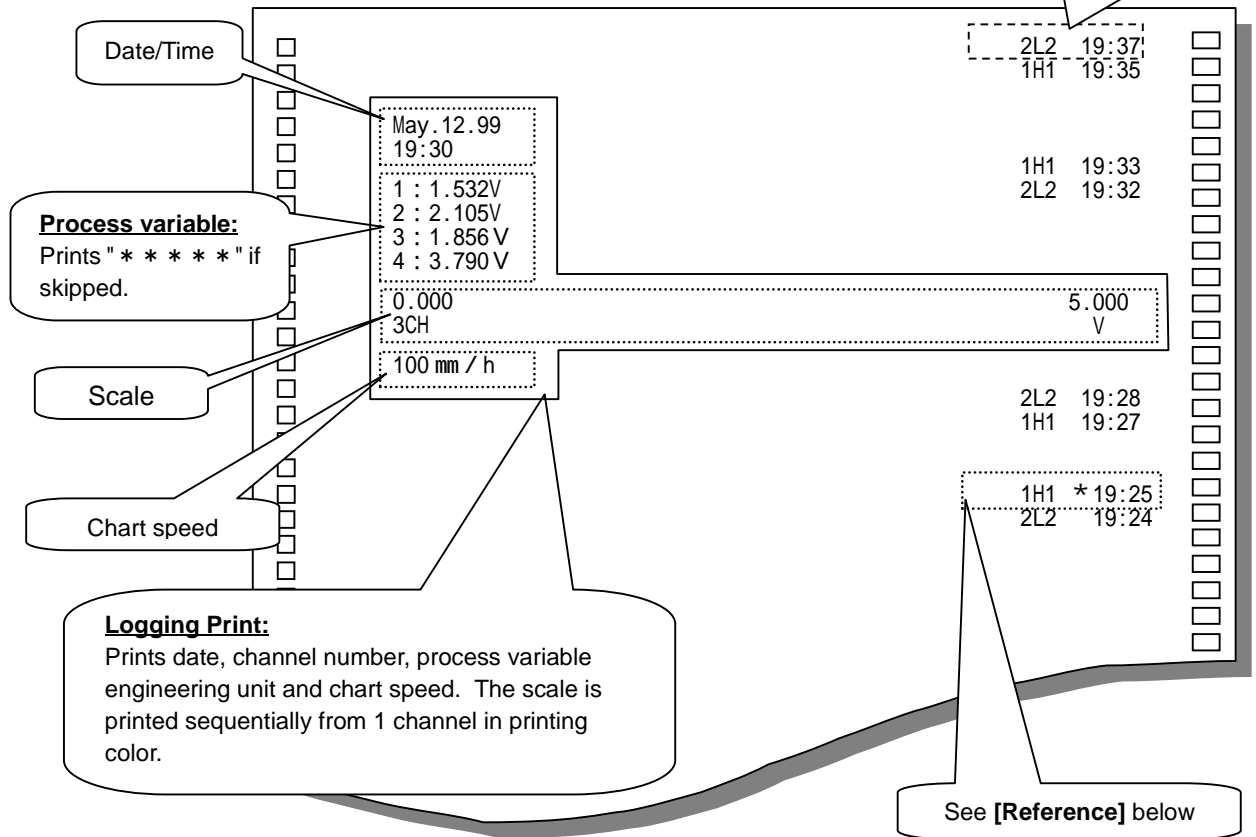

Fig. 6.2 Print Sample

[Reference]

Alarm print, Comment print and Date-and-Time print becomes waited-state if the other printing is actuated. RM10C stores up to six items of Alarm Occurrence/Recovery print and five items of Comment/Date-and-Time print. If printing commands are over, CR06 prints a marking " * " on the end of the last printing. This mark is meaning of that over items would not be printed. For priority of respective printing, see next page; Priority in Reference.

[Note]

Logging print will not be the wait printing state. At the start time of Logging print, if the prior Logging print is printing, the next one cannot print. Prolong the printing interval of Logging print in this case.

6.4 Digital Print

Print the digital print as follows:

- Manual print
- List print
- Engineering list print

[Reference]

Printing is actuated in following priority. See following Priority Order. When multiple types of printing are activated simultaneously, higher-priority printing takes effect first according as following order. In alarm printing activation, lower category (Logging, DI Manual) also is activated. (See Fig. 6.2 that is example : Same time printing of Alarm and Logging print).

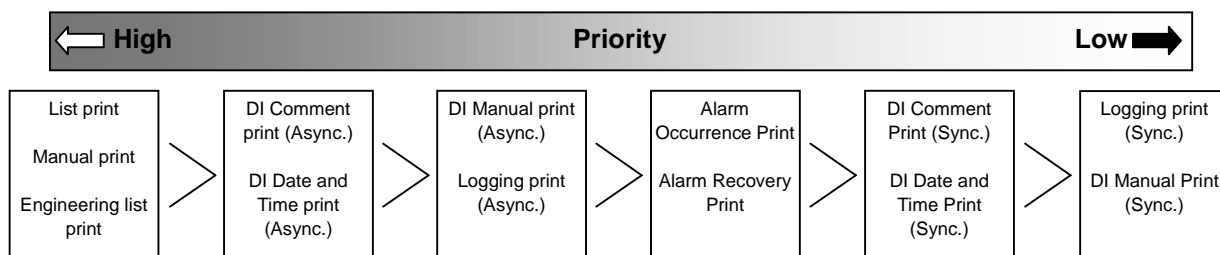

The Synchronous printout synchronizes with the analog record and does a digital printout. In case of the asynchronous printout, it stops an analog record and it executes a digital printout. It resumes an analog record after the digital printout completes.

6.4.1 Manual Print

Print the following data on the chart paper:

- Time/date (year, month, day)
- Channel number or activated alarm type, latest process variable, engineering unit (all channels)

(1) Manual print operating procedure

- ① Press the “PRINT” key.
- ② Use the “PRINT” key to display “**AA**”, and press the “ENT” key.
- ③ Use the “PRINT” key to select “**SEAR**”. Pressing the “ENT” key executes manual print.

Once manual print starts, the display is automatically returned to the Data Display screen.

Upon termination of manual print, it is returned to it was prior to starting manual print.

[Note]

- ① Analog recording is interrupted while manual print is running. However, measurement/alarm detection remains effective.
- ② If an alarm is activated while manual print is running, alarm print will be performed when recording restarts.

(2) Manual print stopping procedure

- ① Press the “PRINT” key.
- ② Use the “PRINT” key to display “**MAN**”, and press the “ENT” key.
- ③ Use the “PRINT” key to select “**STOP**”. Pressing the “ENT” key stops manual print.

However, print operation continues until the line is completed. Manual print is stopped.

And the display returned it was prior to starting manual print.

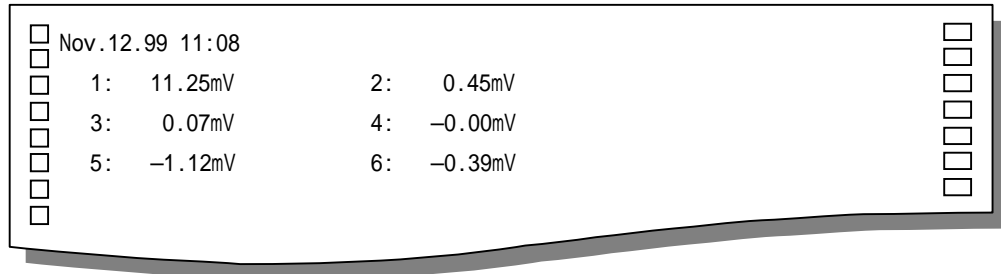

Fig. 6.3 Manual Print

6.4.2 List Print

Print the following setting data of the instrument on the paper:

- Date/time/Chart speed/2nd chart speed/Printing cycle.
- Channel number/range/scaling value/engineering unit
- Setting alarm type

(1) List print operating procedure

- ① Press the “PRINT” key.
- ② Use the “PRINT” key to display “**LI SE**”, and press the “ENT” key.
- ③ Use the “PRINT” key to select “**SEAR-E**”. Pressing the “ENT” key executes list print.

Once list print starts, the display is automatically returned to the Data Display screen.

Upon termination of list print, it is returned to it was prior to starting list print.

[Note]

- ① Analog recording is interrupted while list print is running. However, measurement/alarm detection remains effective.
- ② If an alarm is activated while list print is running, alarm print will be performed when recording restarts.

(2) List print stopping procedure

- ① Press the "PRINT" key.
- ② Use the "PRINT" key to display "LI St", and press the "ENT" key.
- ③ Use the "PRINT" key to select "Stop". Pressing the "ENT" key stops list print.

However, print operation continues until the line is completed. List print is stopped.

And the display returned to it was prior to starting list print.

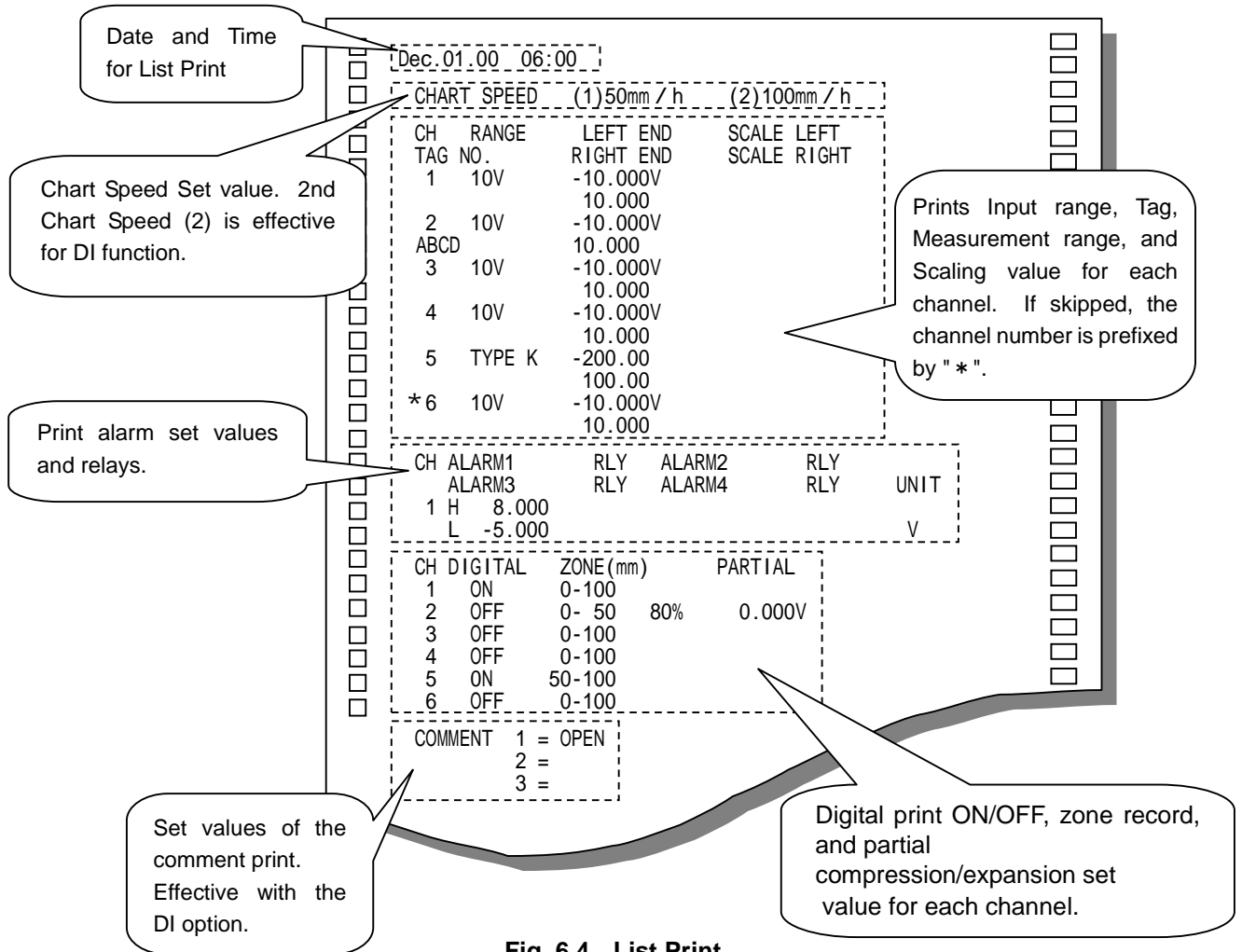

Fig. 6.4 List Print

6.4.3 Engineering List Print

Engineering list print provides the following setting data of the instrument on the chart paper.

- Analog recording
- Digital printing
- Burnout/RJC etc.

(1) Engineering list print operating procedure

- ① Press the “MENU” key.
- ② Use the “PRINT” key to display “ELI SE”, and press the “ENT” key.
- ③ Use the “PRINT” key to select “SEARE”. Pressing the “ENT” key executes engineering list print.

Once engineering list print starts, the display is automatically returned to the Data Display screen.

Upon termination of engineering list print, it is returned to it was prior to starting engineering list print.

[Note]

- ① Analog recording is interrupted while engineering list print is running.
However, measurement/alarm detection remains effective.
- ② If an alarm is activated while engineering list print is running, alarm print will be performed when recording restarts.

(2) Engineering list print stopping procedure

- ① Press the "MENU" key.
- ② Use the "PRINT" key to display "ELI St", and press the "ENT" key.
- ③ Use the "PRINT" key to select "Stop". Pressing the "ENT" key stops engineering list print.

However, print operation continues until the line is completed.

Engineering list print stopped. And the display returned to it was prior to starting engineering list print.

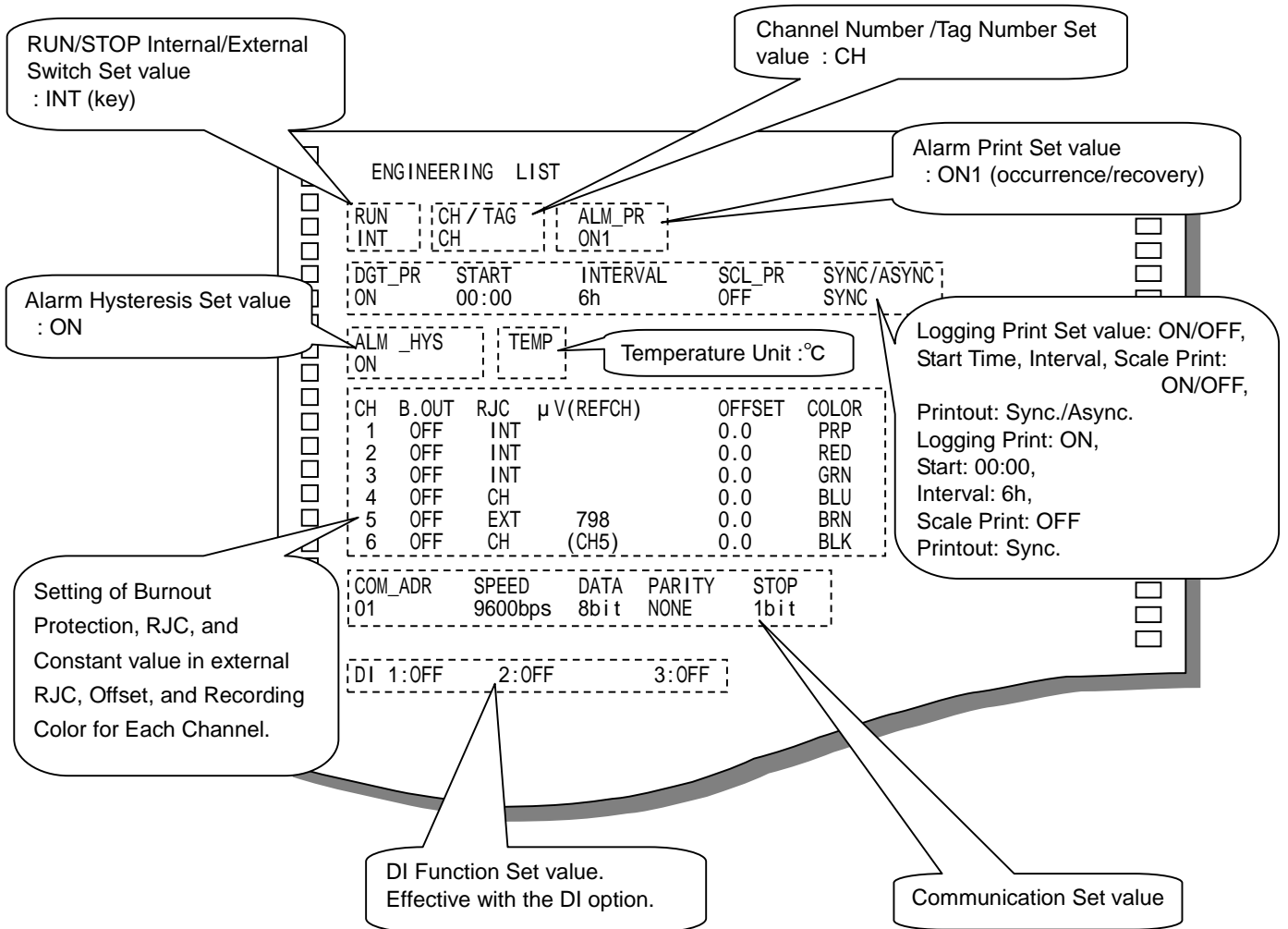

Fig. 6.5 Engineering List Print

6.5 Changing the Display

Display selection procedure

① Press the “MENU” key to display "d: SP", and press the “ENT” key.

② Use the “PRINT” key to select a required display screen from the menu below.

Press the “ENT” key.

③ "CH" is displayed in case of manual display. Use the “PRINT” key to select the channel number.

Press the “ENT” key.

- "AUTO" (AUTO) : Auto display
- "MAN" (MAN) : Manual display
- "DATE" (DATE) : Date display
- "TIME" (TIME) : Time display
- "OFF" (OFF) : Display off

6.5.1 AUTO < Auto Display >

Displays the process variable of each channel sequentially at intervals of 2.5 seconds.

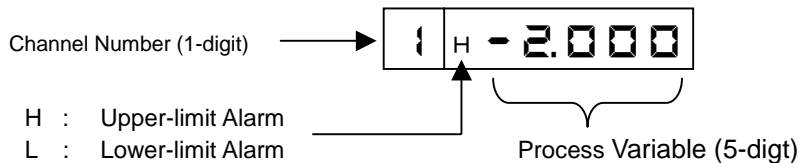

6.5.2 MAN < Manual Display >

Displays the process variable of specific channel, it updates every measurement cycle.

The data is the same as Auto display. Pressing the “ENT” key changes the displayed channel number (it increments).

6.5.3 DATE < Date Display >

Displays the month and day. Leap year adjustment is automatic.

Example of October 18

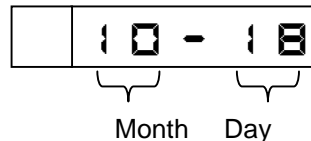

6.5.4 TIME < Time Display >

Displays hour and minute.

Example of 12:15

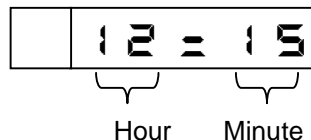

6.5.5 OFF < Display Off >

Turns off the process variable display. Key operation is the same as usual. To switch to other display, take steps ① through ③ mentioned above.

7. DEVICE SETTING

7.1 Setting the Setup Mode

Key Operation for Entering the Setup Mode

Press the “MENU” key for 3 seconds or more to enter the setup mode.

At the time, displays the version of the software approximately 1 seconds as below. After, displays the setting screen of the range.

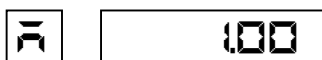

To return from the setup mode to the recording mode (user mode), press the “MENU” key for 3 seconds or more again.

The following describes how to set the following items.

The following shows a display map of the setup mode. Use the Δ key to operate.

7.1.1 Setting the Range

Setting	Channel	Mode	
RANGE	CH1	Wolt	Current/ Voltage Input
	.	EC	Thermocouple Input
	.	red	Resistance temperature detector Input
	.	SCALE	Scaling
	.	SqRt	Square Root
	CH6	DECAD	Decade
		DELt	Difference
		SUM	Sum
		AVER	Average
		SKIP	Skip

7.1.2 Setting the Alarm

Setting	Channel	Level	ON/OFF	Type	Setting value	Option	
						Relay ON/OFF	Relay No.
ALARM	CH1	L1	ON	H	-2.000	ON	1
	.	L2	OFF	L		OFF	.
	.	L3					.
	.	L4					.
	CH6						6

- 7.1.3 Setting the Unit

Setting	Channel	Char. No.	Code No.	
Unit	Ch1	1	Cd 6F	(°)
	:	2	Cd 43	(C)
	:	3	Cd 00	End
	:	4		
	Ch6	5		
		6		

- 7.1.4 Setting the Chart Speed

Setting	1st/2nd Chart speed	Chart speed
CHAR	SPd-1	1500
	SPd-2	

- 7.1.5 Setting the Date and Time

Setting	Year	Month, Day	Time
CLOCK	Y 2000	MO 1-01	EOB-00

- 7.1.6 Copying the Setting Data

Setting	Copy-from Channel	Copy-to Channel
COPY	F Ch1	E Ch2
	F Ch2	E Ch3
	:	:
	F Ch5	E Ch6

- 7.1.7 Setting Other Functions (Printing Cycle, Zone Recording, Partial Compression/Expansion, Digital Print, Tag, Comment Words)

Setting	Mode	
FUN1	trEnd	Printing Cycle
	Zone	Zone Recording
	PartE	Partial Compression/Expansion
	Print	Digital Print
	Tag	Tag
	CanE	Comment Words

- Shift to the engineering mode

Setting	Password
ENG	P 0000

Input the password to go to the engineering mode.
See the key operation in page 67.

Table 7.1 Initial setting value of the setup mode

Setting items	Initial set	Remarks
★Range (all channels)	±10mV Scaling 0~100.0 (°C)	
★Alarm (all channels)	All levels are alarm OFF, relay OFF	
★Engineering unit (all channels)	°C(BF 43 00)	
★Chart speed	(1) 20mm/h (2) 20mm/h	
★Time	2000/01/01, 00:00	Sets up the present time. (Japan standard time) GMT+09:00
★Dot point interval	10 (s)	
★Zone setting (all channels)	0~100 (%)	
★Partial compression/expansion (all channels)	OFF	
★ Digital print (all channels)	ON	
★Tag print character (all channels)	"Blank until the 7th character"	
★Comment print word (1~3)	"Blank until the 16th character"	

7.1.1 Setting the Range

(1) Setting method

With a multirange system, setting the range for each channel is possible.

Use the Δ key to shift the mode ① to ⑩ shown in the Table below.

Set the range from the following input signals. (mode ① to ③)

DC voltage	: $\pm 10, 0$ to $20, 0$ to $50, \pm 200$ mV DC, $\pm 1, 0$ to $5, \pm 10$ V DC
DC current	: 4 to 20 mA DC (External shunt resistor: 250Ω)
Thermocouple	: B, R, S, K, E, J, T, C, Au-Fe, N, PR40-20, PL II, U, L
Resistance temperature detector	: Pt100, JPt100

Set scaling, decade, square root, interchannel sum/difference/average. (mode ④ to ⑨)

Unnecessary channels can be skipped. (mode ⑩)

Setting	Channel	Mode	Key
RANGE	CH 1 CH 2 CH 3 CH 4 CH 5 CH 6	① VOLT (Voltage, Current)	Δ key
		② TC (Thermocouple)	↓
		③ RTD (Resistance temperature detector)	↓
		④ SCALE (Scaling)	↓
		⑤ SQR (Square root)	↓
		⑥ DECADE (Decade)	↓
		⑦ DIFF (Difference)	↓
		⑧ SUM (Sum)	↓
		⑨ AVER (Average)	↓
		Setting for all channels	⑩ SKIP (Skip)

[Note]

A decimal point position can be arbitrary setup only in the "scaling" and "square root" modes. When you want to alter the decimal point position in Voltage/Current/Thermocouple/Resistance temperature detector input set it in the "scaling" mode. To fix the decimal point position, set as follows.

Input	Decimal Places	Input	Decimal Places
mV	2nd place * * * . * *	Thermocouple	1st place * * * * . *
$\pm 1, 0 \sim 5$ V	3rd place * * . * * *	RTD	1st place * * * * . *
± 10 V	2nd place * * * . * *	± 200 mV DC	1st place * * * * . *
mA	2nd place * * * . * *		

(2) **HoLl**(Current/Voltage), **tC**(Thermocouple), **rEd**(Resistance Temperature Detector)

Measures Current, Voltage, Thermocouple and RTD.

Example) When setting Thermocouple T for Channel 1(T :-100 to 300 °C)

Display	Operation keys	Description
	3sec 	Hold down the “MENU” key for 3 seconds or more to enter the setup mode. Displays “rRnge”, then, press the “ENT” key.
		Use the Δ key to select the channel you want to set. Press the “ENT” key.
		Use the Δ key to select the mode. Press the “ENT” key.
		Use the Δ key to select the type. Press the “ENT” key.
 (Zero setting)		Use the Δ key to select a sign and numeral. Use the \triangleright key to shift a digit. Press the “ENT” key.
 (Span setting)		Use the Δ key to select a sign and numeral. Use the \triangleright key to shift a digit. Press the “ENT” key.
		Press the “ENT” key. Setting is completed. To return to the user mode, hold down the “MENU” key for 3 seconds or more.

[Note]

- ① An entry of an incorrect numeral displays an error, or . Press the “ENT” key and re-enter a correct numeral.
- ② For the range setting (When especially, don't change a decimal point position at the thermocouple or in RTD) which doesn't have the necessity of the scaling, don't set a scaling.

[Note]

In the **Vol**, **EC**, or **red** mode, press the “ENT” key.

Use the Δ key, you can select the type out of the range.

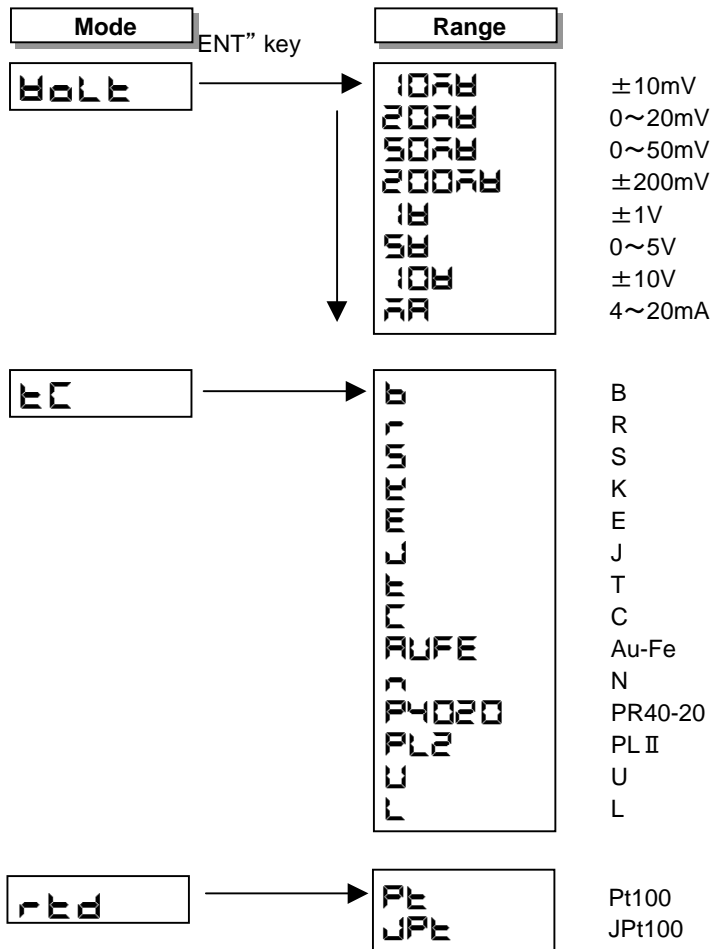

(3) SCALE(Scaling)

Changes the input of VOLT, TC and RTD into a quantity.

Setting the unit is possible.(See 7.1.3 on page 56)

Example) When setting the voltage of 0 to 40 mV and scale of 000.00 to 100.00 for Channel 1.

Display	Operation keys	Description
		Hold down the "MENU" key for 3 seconds or more to enter the setup mode. Use the Δ key to display "r-RANGE". Press the "ENT" key.
		Use the Δ key to select the channel you want to set. Press the "ENT" key.
		Use the Δ key to select "SCALE". Press the "ENT" key.
		Use the Δ key to select "Volt". Press the "ENT" key.
		Use the Δ key to select a range(50 mV). Press the "ENT" key.
 (Zero input value)		Use the Δ key to select a numeral. Use the \triangleright key to shift a digit. Press the "ENT" key.

[Note]

When input TC and RTD, set the Zero input value equal to the Zero-side scale value.
But, set a decimal point position to the standard position. (* 1:next page)

 (Span input value)		Use the Δ key to select a numeral. Use the \triangleright key to shift a digit. Press the "ENT" key.
------------------------	--	--

[Note]

When input TC and RTD, set the Span input value equal to the Span-side scale value.
But, set a decimal point position to the standard position. (* 2:next page)



(Zero-side scale value) (* 1)

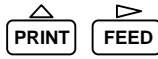

Use the Δ key to select a numeral.

Use the \triangleright key to shift a digit.



(Decimal point)

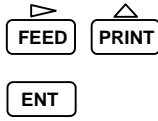

Press the \triangleright key again in the lowest digit(right end)

to blink a decimal point. Use the Δ key to select a

decimal point position. Press the "ENT" key.



(Span-side scale value) (* 2)

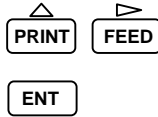

Use the Δ key to select a numeral.

Use the \triangleright key to shift a digit. Press the "ENT" key.

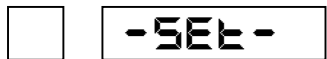

Press the "ENT" key. Setting is completed.

To return to the user mode, hold down the "MENU"

key for 3 seconds or more.

[Note]

An entry of an incorrect numeral displays errors **E** **Err21** or

E **Err24** or **E** **Err25** .

Press the "ENT" key and re-enter a correct numeral.

(4) **√**(Square Root)

Calculates the square root of Volt input, and scaling that value.

Setting the unit is possible. (See 7.1.3 on page 56)

Example) When setting the voltage of 0 to 40 mV and scale of 000.00 to 100.00 for Channel 1.

Display	Operation keys	Description
		Hold down the "MENU" key for 3 seconds or more to enter the setup mode. Use the Δ key to display "-RANGE". Press the "ENT" key.
		Use the Δ key to select the channel you want to set. Press the "ENT" key.
		Use the Δ key to select "√". Press the "ENT" key.
		Use the Δ key to select a range(50 mV). Press the "ENT" key.
 (Zero input value)		Use the Δ key to select a numeral. Use the \triangleright key to shift a digit. Press the "ENT" key.
 (Span input value)		Use the Δ key to select a numeral. Use the \triangleright key to shift a digit. Press the "ENT" key.
 (Zero-side scale value)		Use the Δ key to select a numeral. Use the \triangleright key to shift a digit.
 (Decimal point)		Press the \triangleright key again in the lowest digit(right end) to blink a decimal point. Use the Δ key to select a decimal point position. Press the "ENT" key.
 (Span-side scale value)		Use the Δ key to select a numeral. Use the \triangleright key to shift a digit. Press the "ENT" key.
		Press the "ENT" key. Setting is completed. To return to the user mode, hold down the "MENU" key for 3 seconds or more.

[Note]

An entry of an incorrect numeral indicates an error, or

or .

Press the "ENT" key and re-enter a correct numeral.

About Square Root Computation

The square root computation is as follows:

- Each item is defined as follows:
 - SPAN_L : Span lower-limit value (Span L)
 - SPAN_R : Span upper-limit value (Span R)
 - SCAL_L : Scaling lower-limit value (Scale L)
 - SCAL_R : Scaling upper-limit value (Scale R)
 - IN : Input voltage
 - OUT : Output (Scaling value)

- When an input value is 1 % or more (1 to 100 %)

$$OUT = (SCAL_R - SCAL_L) \times \sqrt{\frac{IN - SPAN_L}{SPAN_R - SPAN_L}} + SCAL_L$$

- When an input value is less than 1 %

$$OUT = \frac{10 \times (SCAL_R - SCAL_L)}{SPAN_R - SPAN_L} \times (IN - SPAN_L) + SCAL_L$$

Example) When makes setting in previous page, the display is as follow table.

Input voltage (mV)	0	10	20	30	40
Display (%)	0.00	50.00	70.71	86.63	100.00

[Note]

The relation between scaling factor and displaying digit may stagger the accuracy rating.

(5) **dECAd**(Decade)

Scaling the VOLT input and displays the index number. Setting the unit is possible. (See 7.1.3 on page 56)

Example) When setting the voltage of 0 to 5 V and decade of 1.0×10^0 to 1.0×10^5 for Channel 1.

Display	Operation keys	Description
	 	Hold down the "MENU" key for 3 seconds or more to enter the setup mode. Use the Δ key to display "RANGE". Press the "ENT" key.
		Use the Δ key to select the channel you want to set. Press the "ENT" key.
		Use the Δ key to select "dECAd". Press the "ENT" key.
		Use the Δ key to select a range(5V). Press the "ENT" key.
 (Zero input value)		Use the Δ key to select a numeral. Use the \triangleright key to shift a digit. Press the "ENT" key.
 (Span input value)		Use the Δ key to select a numeral. Use the \triangleright key to shift a digit. Press the "ENT" key.
 (Zero-side scale value)		Use the Δ key to select a numeral. Use the \triangleright key to shift a digit. Press the "ENT" key.
 (Span-side scale value)		Use the Δ key to select a numeral. Use the \triangleright key to shift a digit. Press the "ENT" key.
		Press the "ENT" key. Setting is completed. To return to the user mode, hold down the "MENU" key for 3 seconds or more.

[Note]

An entry of an incorrect numeral indicates an error, or

or .

Press the "ENT" key and re-enter a correct numeral.

About Decade Display

- Each item is defined as follows:

SPAN _L	: Span lower-limit value (Span L)	
SPAN _R	: Span upper-limit value (Span R)	
SCAL _L	: Scaling lower-limit value (Scale L)	} XXEYY
SCAL _R	: Scaling upper-limit value (Scale R)	
IN	: Input voltage	
OUT	: Output (Scaling value)	

XX: Mantissa section (1.0 to 9.9)

YY: Exponent section (-19 to 19)

Up to 5 decades.

(Scaling upper limit) – (Scaling lower limit) is 1.0E5 or less.

- Decade display abides by the following relational expression.

$$OUT1 = IN \times \frac{LG\ SCAL_R - LG\ SCAL_L}{SPAN_R - SPAN_L} + \frac{SPAN_R \times LGSCAL_L - SPAN_L \times LGSCAL_R}{SPAN_R - SPAN_L}$$

$$OUT = 10^{OUT1}$$

LG SCAL_L :Log₁₀(SCAL_L)

LG SCAL_R :Log₁₀(SCAL_R)

[Note]

Decade output is used for display and print. It is not reflected on a printing position.

Example) When makes setting in previous page, the display is as follow table.

Input voltage (V)	0.0	1.0	2.5	3.0	5.0
Display	1.0E0	1.0E1	3.2E2	1.0E3	1.0E5

(6) dELt(Difference) , S) Cn(Sum) , AEA(Average)

Calculates the input of VOLT, TC, RTD or SCALE, and output.

Example) When subtracting the Ch 1 input data from the Ch 6 input data to set the difference (0 to 40 mV). Records and displays on Ch 6 "Ch 6 (input) - Ch 1(input)".

Display	Operation keys	Description
	3sec 	Hold down the "MENU" key for 3 seconds or more to enter the setup mode. Use the Δ key to display "rRnge". Press the "ENT" key.
 (Setting channel)		Use the Δ key to select the channel you want to set. Press the "ENT" key.
		Use the Δ key to select "dELt". Press the "ENT" key.
 (Reference channel)		Use the Δ key to select the "channel you want to subtract." Press the "ENT" key.
 (Zero input value after difference operation)	 	Use the Δ key to select a numeral. Use the \triangleright key to shift a digit. Press the "ENT" key.
 (Span input value after difference operation)	 	Use the Δ key to select a numeral. Use the \triangleright key to shift a digit. Press the "ENT" key.
		Press the "ENT" key. Setting is completed. To return to the user mode, hold down the "MENU" key for 3 seconds or more.

[Note]

An entry of an incorrect numeral indicates an error, or

or .

Press the "ENT" key and re-enter a correct numeral.

About Difference, Sum, and Average

- The channel to be set must be larger than the one on which computes the "difference, sum, or average". When setting Channel 6, for example, you can subtract the Channel 1 to 5 value.
- The range and scale of the set channel is the same as the channel on which computes the "difference, sum, and average".
- A range value after the computation cannot exceed the maximum range of the instrument.
- Set for the reference channel only the voltage, current, thermocouple, resistance temperature detector, and their scaling ranges.

(7) SET P(Skip)

Setting SKIP on the Channel does not display and recording.

Example) When skipping Channel 6.

Display	Operation keys	Description
<input type="checkbox"/> RANGE	<input type="checkbox"/> ^{ESC} MENU 3sec <input type="checkbox"/> [△] PRINT <input type="checkbox"/> ENT	Hold down the "MENU" key for 3 seconds or more to enter the setup mode. Use the △ key to display "RANGE". Press the "ENT" key.
<input type="checkbox"/> CH6	<input type="checkbox"/> [△] PRINT <input type="checkbox"/> ENT	Use the △ key to select the channel you want to set. Press the "ENT" key.
<input type="checkbox"/> SET P	<input type="checkbox"/> [△] PRINT <input type="checkbox"/> ENT	Use the △ key to select "SET P". Press the "ENT" key.
<input type="checkbox"/> -SET-	<input type="checkbox"/> ENT	Press the "ENT" key. Setting is completed. To return to the user mode, hold down the "MENU" key for 3 seconds or more.

[Note]

Setting all the channels to Skip displays an error, E Err28 .
At least, one channel should be set to measurement.

About Skip

- The skip channel conducts measurement, but does not provide display, print, or alarm judgment. If input is not connected, short-circuit a measurement terminal.

7.1.2 Setting the Alarm

Setting items

Alarm setting to the following two types for each channel is possible.

Alarm point can set up 4 levels for each channel.

Once sets up the alarm point, illuminated "ALM" when a process variable reaches alarm point, and simultaneously, outputs the alarm print indicating an alarm occurrence to the chart paper.

H: Upper-limit alarm ---- When the process variable is higher than the alarm set point, issues an alarm.

L: Lower-limit alarm ---- When the process variable is lower than the alarm set point, issues an alarm.

Operation

Setting	Channel	Level	ON/OFF	Type	Setting value	Option	
						Relay ON/OFF	Relay No.
ALARM	CH1	L1	ON	H	-2.000	ON	1
	.	L2	OFF	L		OFF	.
	.	L3					.
	.	L4					.
	CH6						6

Example) When setting for the Channel 1 alarm point (Level 1) the upper-limit alarm, set value of -2.000, and alarm output relay No. 1.







Display	Operation keys	Description
ALARM	^{ESC} MENU 3sec PRINT ENT	Hold down the "MENU" key for 3 seconds or more to enter the setup mode. Use the Δ key to display "ALARM". Press the "ENT" key.
CH1	PRINT ENT	Use the Δ key to select the channel you want to set. Press the "ENT" key.
L1	PRINT ENT	Use the Δ key to select an alarm level. Press the "ENT" key. Up to 4 levels can be set.
ON	PRINT ENT	Use the Δ key to select alarm setting ON. Press the "ENT" key. Setting "OFF" displays "ALARM" and completes setting.
H	PRINT ENT	Use the Δ key to select an alarm type. Press the "ENT" key.
-2.000	PRINT FEED ENT	Set an alarm point. Use the ▷ key to shift a digit, and use the Δ key to select a numeral. Once setting is completed, press the "ENT" key. A decimal point position is fixed depending on the range.

[Note]

When the "ENT" key is pressed in setting the alarm point. Display will be switched to the next setting display

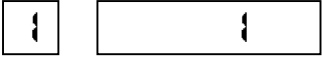
Setting hereinafter is valid only for the model to which an alarm output relay option has been attached. If the option has not been set, press the "ENT" key until "**-SEt-**" is displayed.

Then, press the "ENT" key once more. Setting is completed.

Display	Operation keys	Description
		<p>When an alarm occurs, issues the alarm output from the alarm output relay. Use the Δ key to select alarm output ON and press the "ENT" key.</p> <p>If the alarm output is not used, select OFF and press the "ENT" key.</p>
		<p>If the alarm output is set to ON, set the relay number. Use the Δ key to select the relay number out of 1 to 6, and press the "ENT" key.</p>
		<p>Press the "ENT" key. Setting is completed.</p> <p>When you want to continue to set for other channel, press the Δ key to select the channel, and start setting. To return to the user mode, hold down the "MENU" key for 3 seconds or more.</p>

[Note]

The tag setting does not effect on Alarm print setting. Prints channel numbers every time.

7.1.3 Setting the Unit

Setting Items

Set the unit for each channel.

[Note]

If you change the unit in the range of **Wolt**, **EC** or **red**, setting the range to **SCALE**.

Operation

Setting	Channel	Char. No.	Code No.
Unit	Ch1	1	Cd bF (°)
	.	2	Cd 43 (C)
	.	3	
	.	4	
	Ch6	5	
		6	

Example) Setting the unit(°C) for Channel 1.

Display	Operation keys	Description
	^{ESC} MENU 3sec △ PRINT ENT	Hold down the "MENU" key for 3 seconds or more to enter the setup mode. Use the △ key to display "Unit". Then, press the "ENT" key.
	△ PRINT ENT	Use the △ key to select the channel you want to set. Then, press the "ENT" key.
 (Code No.)	△ ▷ PRINT FEED ENT	Use the △ or ▷ key to select the 1st character of the code number, and press the "ENT" key. See Characters Code Table on the next page.
	△ ▷ PRINT FEED ENT	Set the 2nd character in the same manner.
	△ ▷ PRINT FEED ENT	When the number of unit characters is less than 6, enter a code(00) to end. Press the "ENT" key.
	ENT	Press the "ENT" key. Setting is completed. To return to the user mode, hold down the "MENU" key for 3 seconds or more.

[Note]

The unit setting effects only when the range setting is **SCALE**, **SArt** or **DECAd** (including **dELt**, **S: CA** and **REAr** selected **SCALE** as the reference channel). When the range setting is others, the unit sets appropriate unit for the range automatically.

(1) Character Code Table

	2*	3*	4*	5*	6*	7*	A*	B*	C*	D*	E*	F*
*0	SP	0	@	P		p	o	o		Π		π
*1	!	1	A	Q	a	q	1	1	A	P	α	ρ
*2	"	2	B	R	b	r	2	2	B	Σ	β	σ
*3	#	3	C	S	c	s	3	3	Γ	T	γ	τ
*4	\$	4	D	T	d	t	4	4	Δ	Υ	δ	υ
*5	%	5	E	U	e	u	5	5	E	Φ	ε	φ
*6	&	6	F	V	f	v	6	6	Z	X	ζ	χ
*7	'	7	G	W	g	w	7	7	H	Ψ	η	ψ
*8	(8	H	X	h	x	8	8	Θ	Ω	θ	ω
*9)	9	I	Y	i	y	9	9	I		ι	
*A	*	:	J	Z	j	z			K		κ	
*B	+	;	K	[k	{	+	+	Λ		λ	
*C	,	<	L	¥	l		±	≠	M	△	μ	
*D	-	=	M]	m	}			N	▲	ν	
*E	.	>	N	^	n	—	-	-	≡	▽	ξ	
*F	/	?	O	_	o		o	o	O	▴	o	

Example) The code number for "C" is "43".

7.1.4 Setting the Chart Speed

Setting Items

Set the chart speed. Select it from the table below.

Table 7.2 Chart Speed (Unit: mm/h)

0	1	2	3	4	5	10	15	20	25
30	40	50	60	75	80	90	100	120	150
160	180	200	240	300	360	375	450	600	720
750	900	1200	1500						

Operation

Setting	1st/2nd Chart speed	Chart speed
CHAR-E	SPd-1 SPd-2	1500

Example) When setting the 1st chart speed to 1500 mm/h.

Display	Operation keys	Description
<input type="checkbox"/> CHAR-E	<input type="checkbox"/> ^{ESC} MENU 3sec <input type="checkbox"/> [△] PRINT <input type="checkbox"/> ENT	Press the "MENU" key for 3 seconds or more to enter the setup mode. Use the [△] key to display "CHAR-E", and press the "ENT" key.
<input type="checkbox"/> SPd-1	<input type="checkbox"/> [△] PRINT <input type="checkbox"/> ENT	Use the [△] key to select the 1st chart speed, and press the "ENT" key.

[Note]

When altering the chart speed with the DI option, set the 2nd chart speed.

If the DI option is not attached, setting of the 2nd chart speed becomes invalid.

Display	Operation keys	Description
<input type="checkbox"/> 1500	<input type="checkbox"/> [△] PRINT <input type="checkbox"/> ENT	Use the [△] key to set the 1st chart speed, and press the "ENT" key.
<input type="checkbox"/> -SEt-	<input type="checkbox"/> ENT	Press the "ENT" key. To return to the user mode, hold down the "MENU" key for 3 seconds or more.

[Note]

Restriction of printing
by chart speed

Print type	Chart speed (mm/h)
Alarm occurrence print, Alarm recovery print, Affix print, DI Comment print (Synchronous), DI Date and Time print (Synchronous), DI Manual print (Synchronous)	1~100
Logging print (Synchronous)	10~100

When the chart speed is 0 mm/h, it's printed with forcible chart feed. (When the chart speed is more than 120 mm/h, not printing as shown the Table above.) List Print, Engineering List Print, Manual Print (key), DI Comment print (Asynchronous), DI Date and Time print (Asynchronous), DI Manual print (Asynchronous) and Logging print (Asynchronous) is printed regardless of the chart speed.

7.1.5 Setting the Date and Time

Operation

The following describes how to set the date/time of the internal clock.

Setting	Year	Month, Day	Time
CLoCE	Y 2000	ā 01-01	t 06:00

Example) When setting the date and time to January 1st, 2000, 6:00.

Display	Operation keys	Description
		Hold down the "MENU" key for 3 seconds or more to enter the setup mode. Use the Δ key to display "CLoCE," and press the "ENT" key.
		Set the year. Use the Δ key to select a numeral, and use the \triangleright key to shift a digit. Press the "ENT" key.
		Set the month and day. Operate in the same manner as setting the year.
		Set the time (hours and minutes). Operate in the same manner as setting the year.
		Press the "ENT" key. To return to the user mode, hold down the "MENU" key for 3 seconds or more.

[Note]

If you enter a non-existent dates or time, displays an error
Press the "ENT" key and re-enter a correct numeral.

7.1.6 Copying the Setting Data

Setting Items







The following describes how to copy the setting data of any channel to other channel.

The copy-to channel must be bigger than the copy-from channel.

Operation

Setting	Copy-from Channel	Copy-to Channel
CoPY	F CH1	E CH2
	F CH2	E CH3
	⋮	⋮
	F CH5	E CH6

Example) When copying the setting data of Channel 1 to Channel 2.

Display	Operation keys	Description
 CoPY	 3sec	Hold down the "MENU" key for 3 seconds or more to enter the setup mode. Use the Δ key to display "CoPY", and press the "ENT" key.
F CH1	 	Use the Δ key to select the copy-from channel, and press the "ENT" key.
E CH2	 	Use the Δ key to select the copy-to channel, and press the "ENT" key.
-SEt-		Press the "ENT" key. To return to the user mode, hold down the "MENU" key for 3 seconds or more.

7.1.7 Setting Other Functions

Setting other functions as follows is possible.

Setting Items

① **PrEnd**(Printing cycle)

Select a printing cycle from among 10, 20, 30, and 60 seconds.

② **Zone**(Zone recording)

The data for each channel can be recorded separately in another area so that they will not overlap.

③ **PrEt**(Partial compression/expansion)

Record the measured data of the channel, partially compressed/expanded.

④ **Print**(Digital print)

Specify with ON/OFF whether the measured data for each channel is to be printed or not.

⑤ **TAG**(Tag)

Set the tag, which is to be printed instead of a channel number, for logging print or manual print.

Setting up to 7 characters (select from character code table on page 57), as the tag for each channel is possible.

⑥ **CAnt**(Comment words)

Set the comment words to be printed by DI. There are three kinds of comment words and setting up to 16 characters (select from character code table on page 57) for each DI is possible.

Operation

Setting	Mode	
PrEnd	PrEnd	Printing Cycle
Zone	Zone	Zone Recording
PrEt	PrEt	Partial Compression/Expansion
Print	Print	Digital Print
TAG	TAG	Tag
CAnt	CAnt	Comment Words

(1) **trEnd**(Printing Cycle)

Example) When setting the printing cycle to 60 seconds.

Display	Operation keys	Description
		Hold down the "MENU" key for 3 seconds or more to enter the setup mode. Use the Δ key to display "RUN", and press the "ENT" key.
		Use the Δ key to display "trEnd", and press the "ENT" key.
		Use the Δ key to select the printing cycle "60", and press the "ENT" key.
		Press the "ENT" key. Setting is completed. To return to the user mode, hold down the "MENU" key for 3 seconds or more.

(2) **Zone**(Zone Recording)

Example) When setting the instrument so that Channel 1 zero/span will be recorded at the position of 20 to 50 %.

Display	Operation keys	Description
		Hold down the "MENU" key for 3 seconds or more to enter the setup mode. Use the Δ key to display "RUN", and press the "ENT" key.
		Use the Δ key to display "Zone", and press the "ENT" key.
		Use the Δ key to select the channel you want to set, and press the "ENT" key.
 (Setting of Left-end Position)		Set a zero point printing position in percentage (%). Use the Δ key to select a numeral, and use the \triangleright key to shift a digit. Press the "ENT" key.
 (Setting of Right-end Position)		Set a span printing position in percentage (%). Operate in the same manner as setting the zero point printing position.
		Press the "ENT" key. Setting is completed. To return to the user mode, hold down the "MENU" key for 3 seconds or more.

[Note]

If you enter an incorrect numeral, displays errors , .
Press the "ENT" key and re-enter a correct numeral.

(3) **PARt**(Partial Compression/Expansion)

Example) When setting Channel 1 scale of 0 to 1,000.0 °C to 500.0 °C at a boundary point of 30 %.

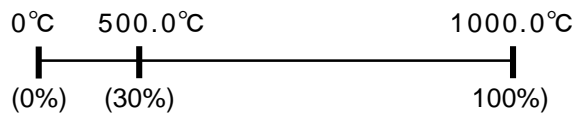

Display	Operation keys	Description
	^{ESC} MENU 3sec PRINT ENT	Hold down the "MENU" key for 3 seconds or more to enter the setup mode. Use the Δ key to display "RUN", and press the "ENT" key.
	Δ PRINT ENT	Use the Δ key to select "PARt", and press the "ENT" key.
	Δ PRINT ENT	Use the Δ key to select the channel you want to set, and press the "ENT" key.
	Δ PRINT ENT	Use the Δ key to select "on", and press the "ENT" key.
	Δ PRINT \triangleright FEED ENT	Set a boundary point position in percentage (%). Use the Δ key to select a numeral, and use the \triangleright key to shift a digit. Press the "ENT" key.
	Δ PRINT \triangleright FEED ENT	Set a boundary point position to "0500.0". Use the Δ key to select a numeral, and use the \triangleright key to shift a digit. Press the "ENT" key.
	ENT	Press the "ENT" key. Setting is completed. To return to the user mode, hold down the "MENU" key for 3 seconds or more.

[Note]

If you enter an incorrect numeral, displays an error .
Press the "ENT" key and re-enter a correct numeral.

(4) Print (Digital Print)

Example) When setting logging channel data print to "ON"(print enabled) for all the channels.

Display	Operation keys	Description
<input type="checkbox"/> Run	^{ESC} <input type="button" value="MENU"/> 3sec <input type="button" value="↑"/> <input type="button" value="PRINT"/> <input type="button" value="ENT"/>	Hold down the "MENU" key for 3 seconds or more to enter the setup mode. Use the Δ key to display "Run", and press the "ENT" key.
<input type="checkbox"/> Print	<input type="button" value="↑"/> <input type="button" value="PRINT"/> <input type="button" value="ENT"/>	Use the Δ key to display "Print", and press the "ENT" key.
<input type="checkbox"/> CH1	<input type="button" value="↑"/> <input type="button" value="PRINT"/> <input type="button" value="ENT"/>	Use the Δ key to select the channel you want to set, and press the "ENT" key.
<input type="checkbox"/> on	<input type="button" value="↑"/> <input type="button" value="PRINT"/> <input type="button" value="ENT"/>	Use the Δ key to switch from "off" to "on", and press the "ENT" key.
<input type="checkbox"/> -Set-	<input type="button" value="ENT"/>	Press the "ENT" key. Setting is completed.
<input type="checkbox"/> CH2	<input type="button" value="↑"/> <input type="button" value="PRINT"/> <input type="button" value="ENT"/>	Repeat setting for each channel.
⋮		
<input type="checkbox"/> CH6	<input type="button" value="↑"/> <input type="button" value="PRINT"/> <input type="button" value="ENT"/>	
<input type="checkbox"/> -Set-	<input type="button" value="ENT"/>	

[Note]

The data for the channel to be skipped is printed " * ".

(5) **⌘** (Tag)

Example) When setting "ABCD" for Channel 1.

Display	Operation keys	Description
		Hold down the "MENU" key for 3 seconds or more to enter the setup mode. Use the Δ key to display "AU 1", and press the "ENT" key.
		Use the Δ key to display "⌘", and press the "ENT" key.
		Use the Δ key to select the channel you want to set, and press the "ENT" key.
 (Setting of 1st Character)		Set "4 1" as the 1st character. Use the Δ key to select a code, and use the \triangleright key to shift a digit. Press the "ENT" key.
 (Setting of 2nd Character)		} Set the 2nd through 4th characters in the same manner.
 (Setting of 3rd Character)		
 (Setting of 4th Character)		
 (Setting of 5th Character)		
		Press the "ENT" key. Setting is completed. To return to the user mode, hold down the "MENU" key for 3 seconds or more..

[Note]

When the number of tag characters is less than 7, set the "00" code next to the last characters. See page 57 for Character Code Table.

(6) $\overline{\text{C}}\overline{\text{A}}\overline{\text{N}}\overline{\text{E}}$ (Comment Words)

Example) When setting "ON" for Comment 1($\overline{\text{C}}\overline{\text{A}}\overline{\text{N}}\overline{\text{E}}$ 1).

Display	Operation keys	Description
	$\overline{\text{MENU}}$ 3sec $\overline{\Delta}$ $\overline{\text{PRINT}}$ $\overline{\text{ENT}}$	Hold down the "MENU" key for 3 seconds or more to enter the setup mode. Use the $\overline{\Delta}$ key to display "RUN", and press the "ENT" key.
	$\overline{\Delta}$ $\overline{\text{PRINT}}$ $\overline{\text{ENT}}$	Use the $\overline{\Delta}$ key to display " $\overline{\text{C}}\overline{\text{A}}\overline{\text{N}}\overline{\text{E}}$ ", and press the "ENT" key.
	$\overline{\Delta}$ $\overline{\text{PRINT}}$ $\overline{\text{ENT}}$	Use the $\overline{\Delta}$ key to select a comment number. Display " $\overline{\text{C}}\overline{\text{A}}\overline{\text{N}}\overline{\text{E}}$ 1" and press the "ENT" key.
 (Setting of 1st Character)	$\overline{\Delta}$ $\overline{\text{PRINT}}$ $\overline{\text{FEED}}$ $\overline{\text{ENT}}$	Set "4F" as the 1st character. Use the $\overline{\Delta}$ key to select a code, and use the $\overline{\triangleright}$ key to shift a digit. Press the "ENT" key.
 (Setting of 2nd Character)	$\overline{\Delta}$ $\overline{\text{PRINT}}$ $\overline{\text{FEED}}$ $\overline{\text{ENT}}$	Set "4E" as the 2nd character. Operate in the same manner as setting the 1st character to end.
 (Setting of 3rd Character)	$\overline{\Delta}$ $\overline{\text{PRINT}}$ $\overline{\text{FEED}}$ $\overline{\text{ENT}}$	Set "00" as the 3rd character. Operate in the same manner as setting the 1st character.
 (Setting of 9th Character)	}	Repeat setting for each channel.
 (Setting of 10th Character)		
 (Setting of 11th Character)		
 (Setting of 16th Character)		
 $\overline{\text{ENT}}$		Press the "ENT" key. Setting is completed. To return to the user mode, hold down the "MENU" key for 3 seconds or more.

[Note]

- When the number of comment characters is less than 16, set the "00" code next to the last characters. See page 57 for Character Code Table.
- The digit is not display after setting the "00".
- The comment setting is not effective without the DI option. Do not set the comment setting.

7.2 Setting the Engineering Mode

Key Operation to Enter the Engineering Mode

Hold down the “MENU” key for 3 seconds or more to enter the setup mode.

Use the Δ key to select “EnG”, and press the “ENT” key then to display “0000”.

Use the Δ key to alter a numeral, and the \triangleright key to shift a digit, enter the password “2222”.

Press the “ENT” key then to display blinking “rESEt”.

Press the “ENT” key. After reset, enter the engineering mode.

The following describes how to set the following items.

The following shows a display map of the Engineering mode. Use the Δ key to operate.

- 7.2.1 Alarm Hysteresis

Setting	ON/OFF	
ALHYS	ON OFF	Set the hysteresis width Cancel the hysteresis width

- 7.2.2 Burnout ON/OFF

Setting	Channel	ON/OFF	
BOUt	CH1 CH2 CHW CHI CHS CH6	ON OFF	Set burnout Cancel burnout

- 7.2.3 Channel Offset

Setting	Channel	OFFSET	
oFSEt	CH1 CH2 CHW CHI CHS CH6	0.0000	Enter an offset value

- 7.2.4 Reference Junction Compensation

Setting	Channel	Function	
rJC	CH1 CH2 CHW CHI CHS CH6	INT EXT CH	Internal Compensation External Compensation Channel Input Compensation

- 7.2.11 Point Calibration

Setting	Function
P Adj	Zero FULL HYS Color

Zero point calibration
Span point calibration
Hysteresis at left/right move
Ribbon select calibration

- 7.2.12 Data Calibration

Setting	Function
d Adj	Volt rtd rjc

Voltage calibration
Resistance temperature detector calibration
Internal reference junction compensation calibration

- 7.3 Terminating the Engineering Mode

Setting	Function
End	Store Abort

Save a set value
Cancel a set value

[Note]

Upon termination if you select "End" and turn off the power without executing "Store", the setting will become invalid. For "End" operation, see Page 81.

Table 7.3 Initial setting value of the engineering mode

Setting items	Initial set	Remarks
★Alarm hysteresis	ON(0.5%)	
★Burnout (all channels)	OFF	
★Channel offset (all channels)	0.0	
★RJC (all channels)	Internal compensation INT	
★Dot print color (1~6channel)	Purple(1), Red(2), Green(3), Blue(4), Brown(5), Black(6)	
★RUN record RUN/STOP trigger Channel/Tag print Alarm print Logging print Logging printing interval Logging print reference time Scale print Logging print Sync/Async	INT Ch OFF ON 6H 00:00 OFF Sync print	Use the RUN key
★COM (communication) Address Baud rate Data length Parity bit Stop bit	01 9600 8bit None 1bit	
★DI (1~3 channel)	OFF	
★Temperature unit	Centigrade Unit	

7.2.1 Alarm Hysteresis

Setting 0.5 % hysteresis to the values at alarm activation and alarm recovery is possible. (Common to all the alarms)

Example) When turning off alarm hysteresis.

Display	Operation keys	Description
<input type="checkbox"/> ALARM	<input type="button" value="ENT"/> <input type="button" value="△"/> <input type="button" value="PRINT"/> <input type="button" value="ENT"/>	Enter the engineering mode (See the key operation in page 67). Use the △ key to display "ALARM", and press the "ENT" key.
<input type="checkbox"/> OFF	<input type="button" value="△"/> <input type="button" value="PRINT"/> <input type="button" value="ENT"/>	Use the △ key to display "OFF", and press the "ENT" key.

7.2.2 Burnout ON/OFF

Setting Burnout High (to deflect the recording over the span) for each channel is possible.

Example) When setting Burnout High for Channel 4.

Display	Operation keys	Description
<input type="checkbox"/> bout	<input type="button" value="ENT"/> <input type="button" value="△"/> <input type="button" value="PRINT"/> <input type="button" value="ENT"/>	Enter the engineering mode (See the key operation in page 67). Use the △ key to display "bout", and press the "ENT" key.
<input type="checkbox"/> CH4	<input type="button" value="△"/> <input type="button" value="PRINT"/> <input type="button" value="ENT"/>	Use the △ key to display "CH4", and press the "ENT" key.
<input type="checkbox"/> on	<input type="button" value="△"/> <input type="button" value="PRINT"/> <input type="button" value="ENT"/>	Use the △ key to select "on", and press the "ENT" key.

7.2.3 Channel Offset

For channel offset setting, set the value to be added to an actual process variable.

Example) When setting the value (3.0) to be added to Channel 3.

Display	Operation keys	Description
<input type="checkbox"/> offset	<input type="button" value="ENT"/> <input type="button" value="△"/> <input type="button" value="PRINT"/> <input type="button" value="ENT"/>	Enter the engineering mode (See the key operation in page 67). Use the △ key to display "offset", and press the "ENT" key.
<input type="checkbox"/> CH3	<input type="button" value="△"/> <input type="button" value="PRINT"/> <input type="button" value="ENT"/>	Use the △ key to select "CH3", and press the "ENT" key.
<input type="checkbox"/> 3.0000	<input type="button" value="△"/> <input type="button" value="PRINT"/> <input type="button" value="FEED"/> <input type="button" value="ENT"/>	Use the △ key to alter a sign/numerical value or shift a decimal point. Use the ▷ key to shift a digit. Once the numerical value is decided, press the "ENT" key.

7.2.4 Reference Junction Compensation

The following describes how to set the method for compensating an electromotive force generated between a thermocouple wire or compensation lead wire and a terminal. There are the following three compensating methods:

- A method to compensate through the built-in temperature sensing element (INT: Internal compensation)
- A method to compensate by keeping an external compensator's temperature constant (EXT: External compensation)
- A method to compensate by one input for the recorder temperature which gets external junction box. (CH: Channel input compensation)

Internal compensation (INT) has been initially set.

Example) When setting the external compensator's temperature constant voltage for Channel 6 to $391 \mu V$. Input the thermocouple T, compensate the external compensator's temperature $10^{\circ}C$ and Input the electromotive force $391 \mu V$.

Display	Operation keys	Description
<div style="display: flex; align-items: center;"> <div style="border: 1px solid black; width: 20px; height: 20px; margin-right: 5px;"></div> <div style="border: 1px solid black; padding: 2px; font-family: monospace; font-size: 1.2em;">r Jc</div> </div>	<div style="display: flex; flex-direction: column; align-items: center;"> <div style="border: 1px solid black; padding: 2px; margin-bottom: 5px;">ENT</div> <div style="display: flex; align-items: center; margin-bottom: 5px;"> <div style="border: 1px solid black; padding: 2px; margin-right: 5px;">△</div> <div style="border: 1px solid black; padding: 2px;">PRINT</div> </div> <div style="display: flex; align-items: center;"> <div style="border: 1px solid black; padding: 2px; margin-right: 5px;">ENT</div> </div> </div>	<p>Enter the engineering mode (See the key operation in page 67). Use the Δ key to display "r Jc", and press the "ENT" key</p>
<div style="display: flex; align-items: center;"> <div style="border: 1px solid black; width: 20px; height: 20px; margin-right: 5px;"></div> <div style="border: 1px solid black; padding: 2px; font-family: monospace; font-size: 1.2em;">CH6</div> </div>	<div style="display: flex; flex-direction: column; align-items: center;"> <div style="border: 1px solid black; padding: 2px; margin-bottom: 5px;">△</div> <div style="display: flex; align-items: center; margin-bottom: 5px;"> <div style="border: 1px solid black; padding: 2px; margin-right: 5px;">PRINT</div> </div> <div style="display: flex; align-items: center;"> <div style="border: 1px solid black; padding: 2px; margin-right: 5px;">ENT</div> </div> </div>	<p>Use the Δ key to select "CH6", and press the "ENT" key.</p>
<div style="display: flex; align-items: center;"> <div style="border: 1px solid black; width: 20px; height: 20px; margin-right: 5px;"></div> <div style="border: 1px solid black; padding: 2px; font-family: monospace; font-size: 1.2em;">E11t</div> </div>	<div style="display: flex; flex-direction: column; align-items: center;"> <div style="border: 1px solid black; padding: 2px; margin-bottom: 5px;">△</div> <div style="display: flex; align-items: center; margin-bottom: 5px;"> <div style="border: 1px solid black; padding: 2px; margin-right: 5px;">PRINT</div> </div> <div style="display: flex; align-items: center;"> <div style="border: 1px solid black; padding: 2px; margin-right: 5px;">ENT</div> </div> </div>	<p>Use the Δ key to select "E11t", and press the "ENT" key.</p>
<div style="display: flex; align-items: center;"> <div style="border: 1px solid black; width: 20px; height: 20px; margin-right: 5px;"></div> <div style="border: 1px solid black; padding: 2px; font-family: monospace; font-size: 1.2em;">00391</div> </div>	<div style="display: flex; flex-direction: column; align-items: center;"> <div style="display: flex; align-items: center; margin-bottom: 5px;"> <div style="border: 1px solid black; padding: 2px; margin-right: 5px;">△</div> <div style="border: 1px solid black; padding: 2px; margin-right: 5px;">PRINT</div> <div style="border: 1px solid black; padding: 2px; margin-left: 5px; margin-right: 5px;">▶</div> </div> <div style="border: 1px solid black; padding: 2px; margin-bottom: 5px;">ENT</div> </div>	<p>Use the Δ key to alter a numerical value, or the \blacktriangleright key to shift a digit. Once the numerical value is decided, press the "ENT" key.</p>
<div style="display: flex; align-items: center;"> <div style="border: 1px solid black; width: 20px; height: 20px; margin-right: 5px;"></div> <div style="border: 1px solid black; padding: 2px; font-family: monospace; font-size: 1.2em;">CH6</div> </div>	<div style="border: 1px solid black; padding: 2px; margin-bottom: 5px;">ENT</div>	<p>Setting is completed. Returned to the channel setting.</p>

Example) When Channel 1 input compensates Channel 6 reference junction.

	Display	Operation keys	Description
<input type="checkbox"/>	rJC	ENT	Enter the engineering mode (See the key operation in page 67). Use the Δ key to display
<input type="checkbox"/>	CH6	Δ PRINT ENT	"rJC", and press the "ENT" key.
<input type="checkbox"/>	CH	Δ PRINT ENT	Use the Δ key to select "CH6", and press the "ENT" key.
<input type="checkbox"/>	CH 1	Δ PRINT ENT	Use the Δ key to select "CH", and press the "ENT" key.
<input type="checkbox"/>	CH6	Δ PRINT ENT	Use the Δ key to select "CH 1", and press the "ENT" key.
<input type="checkbox"/>	CH6		Setting is completed. Returned to the channel setting.

7.2.5 Changing the Printing Color

Change a printing color can be changed for each channel.

Example) When setting the black color as a printing color.

	Display	Operation keys	Description
<input type="checkbox"/>	CoLoR	ENT	Enter the engineering mode (See the key operation in page 67). Use the Δ key to display
<input type="checkbox"/>	CH 1	Δ PRINT ENT	"CoLoR", and press the "ENT" key.
<input type="checkbox"/>	blE	Δ PRINT ENT	Use the Δ key to select "CH 1", and press the "ENT" key.
<input type="checkbox"/>	CoLoR	Δ PRINT FEED ENT	Use the Δ key to display "blE", and press the "ENT" key.
			Setting is completed. Returned to the Printing Color Setting screen.



















7.2.6 Settings Related to Recording

Setting a recording start/stop trigger, select tag/channel print selection, alarm print, logging print, and scale print ON/OFF is possible.

(1) Recording start/stop trigger setting

Set whether the trigger of recording start/stop should be by the "RUN" key or DI.

Example) When setting DI as the recording start/stop trigger.

Display	Operation keys	Description
<input type="checkbox"/> 	   	Enter the engineering mode (See the key operation in page 67). Use the Δ key to display "rUn", and press the "ENT" key.
<input type="checkbox"/> 	  	Use the Δ key to select "rUn.tG", and press the "ENT" key.
<input type="checkbox"/> 	  	Use the Δ key to display "E)It", and press the "ENT" key.
<input type="checkbox"/> 	   	Setting is completed. Returned to the Recording Start/Stop Setting screen.











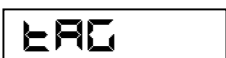

[Note]

When displays "E)It", "RUN/STOP" key does not operate. Set "rCd" to DI.
See DI functions in page 77.

(2) Tag/channel print selection

In case of logging print; or manual print, set whether a tag or channel should be printed.

Example) When setting the tag.

Display	Operation keys	Description
<input type="checkbox"/> 	   	Enter the engineering mode (See the key operation in page 67). Use the Δ key to display "rUn", and press the "ENT" key.
<input type="checkbox"/> 	  	Use the Δ key to select "tAG", and press the "ENT" key.
<input type="checkbox"/> 	  	Use the Δ key to display "tAG", and press the "ENT" key.
<input type="checkbox"/> 		Setting is completed. Returned to the Tag/Channel Setting screen.

(3) Alarm print ON/OFF

Setting the alarm print ON/OFF.

When ON1, prints the alarm occurring and the alarm recovering. When ON2, prints only the alarm occurring.

Example) When sets both the alarm occurring and the alarm recovering.

Display	Operation keys	Description
		Enter to the engineering mode (See the key operation in page 67). Use the Δ key to display "rUn", and press the "ENT" key.
		Use the Δ key to select "ALARā", and press the "ENT" key.
		Use the Δ key to display "on 1", and press the "ENT" key.
		Setting is completed. Returned to the Alarm Print Setting screen.

(4) Logging print ON/OFF

Set logging print to ON/OFF.

In case of logging print ON, set the print start time and print interval.

Example) When you want logging print to start at 18:00 every day.

Display	Operation keys	Description
		Enter the engineering mode (See the key operation in page 67). Use the Δ key to display "rUn", and press the "ENT" key.
		Use the Δ key to select "dOEt.Pr", and press the "ENT" key.
		Use the Δ key to display "on", and press the "ENT" key.
 (Print Start Time)		Use the Δ key to alter a numeral, and \triangleright key to shift a digit. Then, set the time and press the "ENT" key.
 (Interval)		Use the Δ key to display "24H", and press the "ENT" key.
		Setting is completed. Returned to the Logging print Setting screen.

(5) Scale print ON/OFF

Set scale print to ON/OFF.

Example) When setting scale prints to OFF.

Display	Operation keys	Description
<input type="checkbox"/> rUn	ENT △ PRINT ENT	Enter the engineering mode (See the key operation in page 67). Use the △ key to display "rUn", and press the "ENT" key.
<input type="checkbox"/> SCALE	△ PRINT ENT	Use the △ key to select "SCALE", and press the "ENT" key.
<input type="checkbox"/> OFF	△ PRINT ENT	Use the △ key to display "OFF", and press the "ENT" key.
<input type="checkbox"/> SCALE		Setting is completed. Returned to the Scale Print Setting screen.

(6) Logging print Synchronous/Asynchronous

Set logging print to synchronous print/asynchronous print.

















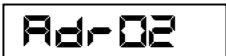







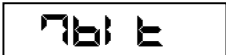

Example) When setting logging print to asynchronous print.

Display	Operation keys	Description
<input type="checkbox"/> rUn	ENT △ PRINT ENT	Enter the engineering mode (See the key operation in page 67). Use the △ key to display "rUn", and press the "ENT" key.
<input type="checkbox"/> dSYnC	△ PRINT ENT	Use the △ key to select "dSYnC", and press the "ENT" key.
<input type="checkbox"/> ASYnC	△ PRINT ENT	Use the △ key to display "ASYnC", and press the "ENT" key.
<input type="checkbox"/> dSYnC		Setting is completed. Returned to the logging print Sync/Async Setting screen.

7.2.7 Setting the Communication Function

Set Local Address, Baud Rate (communication speed), Data Length, Parity Bit, and Stop Bit.











Example) Local Address: 02, Baud Rate: 1200bps, Data Length: 7 bit, Parity Bit: even, Stop Bit: 2 bit.

Display	Operation keys	Description
 	  	Enter the engineering mode (See the key operation in page 67). Use the Δ key to display "Coñ", and press the "ENT" key.
 	 	Use the Δ key to display "Ad-02", and press the "ENT" key.(Select from Ad-0 1~Ad-3 2)
 	 	Use the Δ key to display "1200", and press the "ENT" key. (Select from 1200, 2400, 4800, 9600)
 	 	Use the Δ key to display "7bit", and press the "ENT" key. (Select from 7 bit, 8 bit)
 	 	Use the Δ key to display "EVEN", and press the "ENT" key. (Select from EVEN, ODD and NONE)
 	 	Use the Δ key to display "2bit", and press the "ENT" key. (Select from 1 bit, 2 bit)
 		Setting is completed. Returned to the Communication Function Setting screen.

7.2.8 Initializing the Setup Data

Put back the setup data to what they were at shipment from the factory.

Example) When you initialize the Setup Data.

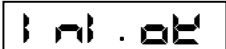

Display	Operation keys	Description
 	  	Enter the engineering mode (See the key operation in page 67). Use the Δ key to display "Init", and press the "ENT" key.
 	 	Use the Δ key to select "YES", and press the "ENT" key.
 		Initialization is completed.

7.2.9 DI Functions

Allocate the functions to three DIs. There are the following 12 DI functions.

No function	: OFF
Manual print (Sync.)	: AAAP (Positive edge: running start)
Manual Print (Async.)	: AAAAP (Positive edge: running start)
RUN/STOP trigger function	: rCd (ON:RUN, OFF:STOP)
Date/Time Print (Sync.)	: t AAP (Positive edge: running start)
Date/Time Print (Async.)	: At AP (Positive edge: running start)
Chart speed selection	: SPEED (ON:Spd-1, OFF:Spd-2)
Comment print 1-3 (Sync.)	: CAte 1, CAte 2, CAte 3 (Positive edge: running start)
Comment print 1-3 (Async.)	: ACAt 1, ACAt 2, ACAt 3 (Positive edge: running start)

Example) When setting comment prints 3 for DI3.

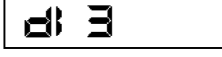
Display	Operation keys	Description
<input type="checkbox"/> 	<input type="button" value="ENT"/>	Enter the engineering mode (See the key operation in page 67). Use the Δ key to display
<input type="checkbox"/> 	<input type="button" value="PRINT"/> <input type="button" value="ENT"/>	"di ", and press the "ENT" key.
<input type="checkbox"/> 	<input type="button" value="PRINT"/> <input type="button" value="ENT"/>	Use the Δ key to select "di 3", and press the "ENT" key.
<input type="checkbox"/> 	<input type="button" value="PRINT"/> <input type="button" value="ENT"/>	Use the Δ key to display "CAte 3", and press the "ENT" key.
		Setting is completed. Returned to the DI3 Function Setting screen.



[Note]

The setting is OFF without the DI option. Do not set any setting except for OFF.

7.2.10 Temperature Unit

It changes the setting of a temperature unit.

Example) When setting a temperature unit to being Fahrenheit.

Display	Operation keys	Description
<input type="checkbox"/> 	<input type="button" value="ENT"/>	Enter the engineering mode (See the key operation in page 67). Use the Δ key to indicate
<input type="checkbox"/> 	<input type="button" value="PRINT"/> <input type="button" value="ENT"/>	"tEAP", and press the "ENT" key.
<input type="checkbox"/> 	<input type="button" value="PRINT"/> <input type="button" value="ENT"/>	Use the Δ key to select "F", and press the "ENT" key.
		Setting is completed. Returned to the Temperature Unit Setting screen.

[Note]

When changes temperature unit, all set up data (configuration) becomes initial.

7.2.11 Point Calibration

Calibrate a dot printing position.

Zero: Calibration of the zero point position

FULL: Calibration of the span point position

[Note]
Point calibration "HYS" and "Color" are setup item before shipment. Do not change the setup value.

Example) When calibrating the zero point.

Display	Operation keys	Description
<input type="checkbox"/> P Adj	ENT △ PRINT ENT	Enter the engineering mode (See the key operation in page 67). Use the △ key to display "P Adj", and press the "ENT" key.
<input type="checkbox"/> Zero	△ PRINT ENT	Use the △ key to select "Zero", and press the "ENT" key.
<input type="checkbox"/> 00003	△ PRINT FEED ENT	The instrument starts to feed and print the chart paper. With the △ (left move) and ▷ (right move), adjust the 0 mm position of the chart paper and the recording position. Press the "ENT" key. Display displays the set counter value.
<input type="checkbox"/> Zero		Setting is completed. Returned to the Zero Point Calibration screen.

Example) When calibrating the span point.

Display	Operation keys	Description
<input type="checkbox"/> P Adj	ENT △ PRINT ENT	Enter the engineering mode (See the key operation in page 67). Use the △ key to display "P Adj", and press the "ENT" key.
<input type="checkbox"/> FULL	△ PRINT ENT	Use the △ key to select "FULL", and press the "ENT" key.
<input type="checkbox"/> 0 1003	△ PRINT FEED ENT	The instrument starts to feed and print the chart paper. With the △ (left move) and ▷ (right move), adjust the 100 mm position of the chart paper and the recording position. Press the "ENT" key. Display displays the set counter value.
<input type="checkbox"/> FULL		Setting is completed. Returned to the Span Point Calibration screen.

7.2.12 Data Calibration

Calibrate the voltage, resistance temperature detector, and reference junction compensation.

Volte : Calibration of the voltage

rtd : Calibration of the resistance temperature detector

rJC : Calibration of reference junction compensation

Example) When calibrating the voltage at Channel 1.

Display	Operation keys	Description
d Adj	 	Enter the engineering mode (See the key operation in page 67). Use the Δ key to display "d Adj", and press the "ENT" key. Use the Δ key to select "Volte", and press the "ENT" key.
Volte		Select the channel where an instrument for calibration such as a mV generator is connected, and then, press the "ENT" key.
Ch 1		
00mV		Enter 0 mV. After 30 seconds, make sure that the ALM lamp unilluminates and press the "ENT" key.
15mV		Enter 15 mV. After 10 seconds, make sure that the ALM lamp unilluminates and press the "ENT" key.
25mV		Enter 25 mV. After 10 seconds, make sure that the ALM lamp unilluminates and press the "ENT" key.
35mV		Enter 35 mV. After 10 seconds, make sure that the ALM lamp unilluminates and press the "ENT" key.
55mV		Enter 55 mV. After 10 seconds, make sure that the ALM lamp unilluminates and press the "ENT" key.
200mV		Enter 200 mV. After 10 seconds, make sure that the ALM lamp unilluminates and press the "ENT" key.
1.0V		Enter 1 V. After 10 seconds, make sure that the ALM lamp unilluminates and press the "ENT" key.
5.0V		Enter 5 V. After 10 seconds, make sure that the ALM lamp unilluminates and press the "ENT" key.
10.0V		Enter 10 V. After 10 seconds, make sure that the ALM lamp unilluminates and press the "ENT" key.
Store		If the calibration is correct, select "Store" with the Δ key, and if incorrect, select "Abort", respectively. Then, press the "ENT" key.

[Note]
For calibration for voltage input, only one channel calibration is effective to all the channel.

Example) When calibrating the resistance temperature detector at Channel 2.

Display	Operation keys	Description
	ENT △ PRINT ENT	<p>Enter the engineering mode (See the key operation in page 67). Use the Δ key to display "d Adj", and press the "ENT" key. Use the Δ key to select "rtd", and press the "ENT" key. Select the channel where the instrument for calibration such as a dial resistor is connected and then, press the "ENT" key.</p> <p>Enter 100 Ω. After 10 seconds, make sure that the ALM lamp unilluminates and press the "ENT" key.</p> <p>Enter 150 Ω. After 10 seconds, make sure that the ALM lamp unilluminates and press the "ENT" key.</p> <p>Enter 300 Ω. After 10 seconds, make sure that the ALM lamp unilluminates and press the "ENT" key.</p> <p>If the calibration is correct, select "Store" with the Δ key, and if incorrect, select "Abort", respectively. Then, press the "ENT" key.</p>
	△ PRINT ENT	
	△ PRINT ENT	
	ENT	
	ENT	
	ENT	
	△ PRINT ENT	

[Note]

When calibrate RTD for a channel, the input terminals of the other channels are shortcut. Recording requires RTD calibration for every channel.

[Note]

During calibration, ALM lamp displays following conditions below.

① Unilluminating the ALM lamp

The calibration is within the range.



② Blinking the ALM lamp

Judges the input value.



displays unilluminating the lamp.
 displays illuminating the lamp.

③ Illuminating the ALM lamp

Make sure that the connection is properly or input is correctly.

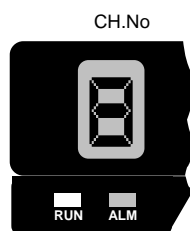

Example) When setting the terminal temperature for Channel 1.

Display	Operation keys	Description
<input type="checkbox"/> d Adj	ENT △ PRINT ENT	Enter the engineering mode (See the key operation in page 67). Use the △ key to display "d Adj", and press the "ENT" key.
<input type="checkbox"/> rJC	△ PRINT ENT	Use the △ key to select "rJC", and press the "ENT" key.
<input type="checkbox"/> r CH 1	△ PRINT ENT	Select the Channel to set, and press the "ENT" key.
<input type="checkbox"/> 24.5	ENT	Measure and display the real time terminal temperature. When press the "ENT" key, turn to the setting temperature display.
<input type="checkbox"/> 25.0	△ PRINT FEED ENT	Use the △ key to alter a numeral, and ▷ key to shift a digit. Then, press the "ENT" key. See 9.5 (3) Calibration of Reference Junction Compensation.
<input type="checkbox"/> Store	△ PRINT ENT	If the calibration is correct, select "Store" with the △ key, and if incorrect, select "Abort", respectively. Then, press the "ENT" key.

[Note]

When calibrate the terminal temperature, select a channel to calibrate for channel 1 to channel 3, and select another channel for channel 4 to channel 6. Calibrate these channels separately.

7.3 Terminating the Engineering Mode

Example) The following describes how to save the setting data.

Display	Operation keys	Description
<input type="checkbox"/> End	△ PRINT ENT	Use the △ key to display "End", and press the "ENT" key.
<input type="checkbox"/> Store	ENT	Use the △ key to select "Store", and press the "ENT" key. The settings of the engineering mode have been saved. Recording starts under the new settings.

[Note]

Upon termination, if you select "End" and turn off the power without selecting "Store", the settings will become invalid. Selecting "Abort" invalidates the settings and starts recording under the previous settings.

8. COMMUNICATIONS

8.1 General Description

8.1.1 General Description of Functions

This Recorder has the following communication functions:

- ① Outputting the process variable
Process variable, alarms status, etc.
- ② Outputting the set value
Reading the setup data such as a range, chart speed, etc.
- ③ Inputting the set value
Writing the setup data such as a range, chart speed, etc.
- ④ Controlling of the recorder (Partially)
Selection to print, recording start/stop and changing display etc.

For the functions ② to ④, see the separate Communication Command Reference Manual (charged). Setting the engineering mode is not capable with communication.

8.1.2 Transmission Specifications

- | | |
|--------------------------|---|
| (1) Communication system | :Start-stop synchronous, half-duplex communications |
| (2) Connection | :One-to-one(RS-232C), One-to-N(RS-485); N = 1 to 32 |
| (3) Communication speed | :1200, 2400, 4800, or 9600 bps |
| (4) Start bit | :1 bit |
| (5) Stop bit | :1 or 2 bits |
| (6) Parity | :Even, Odd, or None |
| (7) Data length | :7 or 8 bits |

8.1.3 Data Construction

- (1) Character construction

In order to send one data (byte) in start-stop synchronous communications, the following character construction is assumed:

Start Bit (1) + Data Bit (7 or 8) + Parity Bit (1) + Stop Bit (1 or 2)

- (2) Data format

The communication data is sent with data terminators added to multiple characters. Upon receiving these terminators, the recorder starts analyzing the communication data.

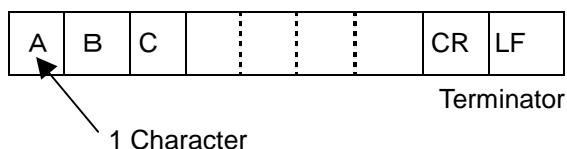

(3) Error Detection

If the recorder receives the data that has resulted in a signal error such as a parity error, framing error, etc. due to the noise or hardware troubles, it will ignore that data. Consequently, a data format error results, determining that the data is not sent in the normal data format. The receiving function does not execute that command and the transmitting function does not reply. The data format error status can be confirmed by the ESC S command (described later).

(4) Control codes

ESC: 1B HEX (hexadecimal)

This code is used for an escape sequence such as opening/closing the link.

It cannot be treated as part of the text data.

CR: 0D HEX (hexadecimal)

This data is added to the end of the text data together with the LF data.

This code cannot be treated as part of the text data.

LF: 0A HEX (hexadecimal)

This data is added to the end of the text data together with the CR data.

This code cannot be treated as part of the text data.

8.2 Opening/Closing the Link

To communicate with the recorder, you must establish a connection between the host computer and the recorder. In case of one-to-N communications, it is necessary to inform each recorder which recorder the text is being sent. If a link open command is sent to multiple recorders through their send function, all the recorders, which have received the command, will send and cannot receive the normal data.

8.2.1 Open Command

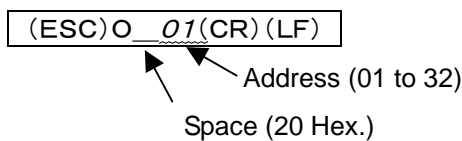

For the host computer to communicate the recorder, it must issue this command and memorize that it has been issued.

8.2.2 Close Command

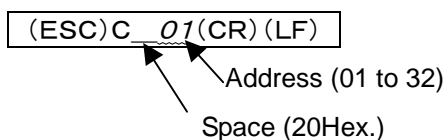

For the host computer to communicate with the recorder, this command must be issued to the open-link recorder, if you want to send the data to the recorders, which have not issued the open command.

8.3 Outputting the Process Variable Data

8.3.1 Specifying the Process Variable Data Output

`TS0(CR)(LF)`

Once this command is received, the recorder transfers the process variable data to the transmit buffer, when the (ESC) T command is received.

8.3.2 Updating the Data

`(ESC)T(CR)(LF)`

Once this command is received, the recorder transfers the update process variable data to the transmit buffer.

8.3.3 Specifying the Process Variable Data Output Order (At BINARY Mode Output)

`BO0(CR)(LF)` Outputs starting from the upper byte.

`BO1(CR)(LF)` Outputs starting from the lower byte.

The recorder outputs starting from the lower byte, unless otherwise specified.

8.3.4 Outputting the Data

`FM0, S_CH, E_CH` Specifies the ASCII mode output.

`FM1, S_CH, E_CH` Specifies the BINARY mode output.

S_CH :Output start channel 01 to 06

E_CH :Output end channel 01 to 06

※ When the number of channels is one, specify (S_CH) = (E_CH).

8.3.5 Process Variable Data Transmission Format (ASCII)

`DATE(YY)(MM)(DD)(CR)(LF)` Date
Year Month Day

`TIME(HH)(MM)(SS)(CR)(LF)` Time
Hour Minute Second

`(DS1)(DS2)(ALM1)(ALM2)(ALM3)(ALM4)(UNIT1~6)(CHNo.)(DATA)(CR)(LF)`

(1) DS1 :Data information 1 (1 byte)

N : Normal
D : Difference computation data
S : Sum computation data
M : Average computation data
R : Square root computation data
C : Decade computation data
O : Over range (Data = ± 9999)
S : Skip (All the data are spaces)

(2) DS2 :Data information 2 (1 byte)

E : Final data
_(Space) :Other data

(3) ALM1 to 4 : Alarm information (1 byte each, 4 bytes in total)

H : Upper-limit alarm
L : Lower-limit alarm
_(Space) : Alarm OFF or alarm setting OFF.

(4) UNIT1 to 6 :UNIT(6 bytes)

Returns the set unit in terms of code. (When sending the 7-bit data, the higher 1 bit is missing.)

(5) CHNo. : Channel number (2 bytes)

01~06

(6) DATA :Process variable data

Sign(1 byte) : "+" or "-"

Data mantissa section (6 bytes) : 00000~99999

Data exponent section (4 bytes) : E (Sign: 1 byte) (Multiplier: 2 bytes)

<Example> +99999E-02

8.3.6 Process Variable Data Transmission Format (BINARY)

Output bytes	Date and time	Process variable 1	Process variable 6
--------------	---------------	--------------------	--------------------

Output bytes (2 bytes) : $5 \times n$ (specified number of channels+6)

(1) Date and time (6 bytes):

①	②	③	④	⑤	⑥
---	---	---	---	---	---

- ① Year : 00H to 63H (00H for the year 2000)
- ② Mouth : 01H to 0CH
- ③ Day : 01H to 1FH
- ④ Hour : 00H to 17H (24-hour system)
- ⑤ Minute: 00H to 3BH
- ⑥ Second: 00H to 3BH

(2) Process variable (5 bytes):

CHNo.	A2	A1	A4	A3	DATA1	DATA2
-------	----	----	----	----	-------	-------

CHNo.(1BYTE) : Channel number 01H~06H

A1 to A4 (2BYTES) : Alarm type activated at each alarm level.

1 : Upper-limit alarm

2 : Lower-limit alarm

0 : Alarm OFF or alarm setting OFF

Example) Bit Sequence.

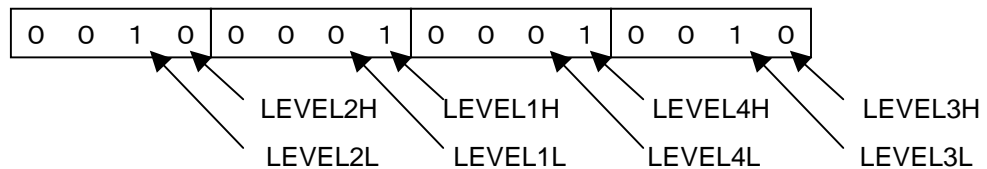

LEVEL × H : Upper-limit alarm bit at the alarm level x

LEVEL × L : Lower-limit alarm bit at the alarm level x

DATA 1, DATA 2 (2BYTES) : Process variable data

– 32000 to + 32000 (2-byte hexadecimal data)

The higher and lower bytes can be reversed by the BO command.

If Skip is specified, 8080H will be output.

[Note]

- Outputs a data over -32000 to +32000 as the overflow. An overflow 7E7E is output on plus side, and 8181 is output on minus side. Excluding the Decade channel.
- It outputs data output by the Decade channel as follows regardless of the BO command. The upper byte outputs a mantissa (10 to 99). The lower byte outputs an exponent (-19 to 19). A decimal point position is fixed on 1 digit.

8.4 Outputting the Unit and Decimal Point Position Data

8.4.1 Specifying the Unit and Decimal Point Position Data Output

`TS2(CR)(LF)`

Once this command is received, the recorder transfers the unit and decimal point position data to the transmit buffer, when the (ESC) T command is received.

8.4.2 Updating the Data

`(ESC)T(CR)(LF)`

Once this command is received, the recorder transfers the update unit and decimal point position data to the transmit buffer.

8.4.3 Outputting the Data

`LF, S__CH, E__CH`

S__CH :Output start channel 01 to 06

E__CH :Output end channel 01 to 06

※ When the number of channels is one, specify (S_CH) = (E_CH). __ (Space)

8.4.4 Data Format

`(DS1)(DS2)(CHNo.)(UNIT1~6)(DP)`

(1) DS1 :Data information 1 (1 byte)

N : Normal

D : Difference computation data

S : Sum computation data

M : Average computation data

R : Square root computation data

C : Decade computation data,

O : Over range (Data = ±99999)

S : Skip (All the data are spaces)

(2) DS2 :Data information 2 (1 byte)

E :Final data,

__(Space) :Other data

(3) CHNo. :Channel number (2bytes) ;01~06

(4) UNIT 1 to 6 :UNIT

Returns the set unit in terms of code. (When sending the 7-bit data, the higher 1 bit is missing.)

(5) DP :Decimal point information (1 byte) ;0~4

[Note]

By the range setting, a decimal point position may differ from a display screen.

8.5 Outputting the Status

If the open-link recorder has a data error on its link, it will save the error as a communication error in the internal status area. The (ESC S) command reads this status. Issuing this command clears the on-going error.

8.5.1 Status Output Command

```
ESC S(CR)(LF)
```

Receiving this command outputs the status for the command received so far.

8.5.2 Status Output

```
E R X X CR LF
```

XX : 00~19

Table 8.1 Status output list

Status factor Status output	Status factor		
	A/D END	Syntax error	記録紙切れ
ER 00 C _R L _F			
ER 01 C _R L _F	○		
ER 02 C _R L _F		○	
ER 03 C _R L _F	○	○	
ER 04 C _R L _F			
ER 05 C _R L _F	○		
ER 16 C _R L _F			○
ER 17 C _R L _F	○		○
ER 18 C _R L _F		○	○
ER 19 C _R L _F	○	○	○

○: The factor from which status is ENABLE.

A/D END : When carrying out AD conversion end, it occurs.

Syntax error : It occurs during a communication error or a command error occurs.

Paper-empty : When Paper-empty is found, it occurs.

(The Paper-empty option has been attached)

8.6 Data Reception Example

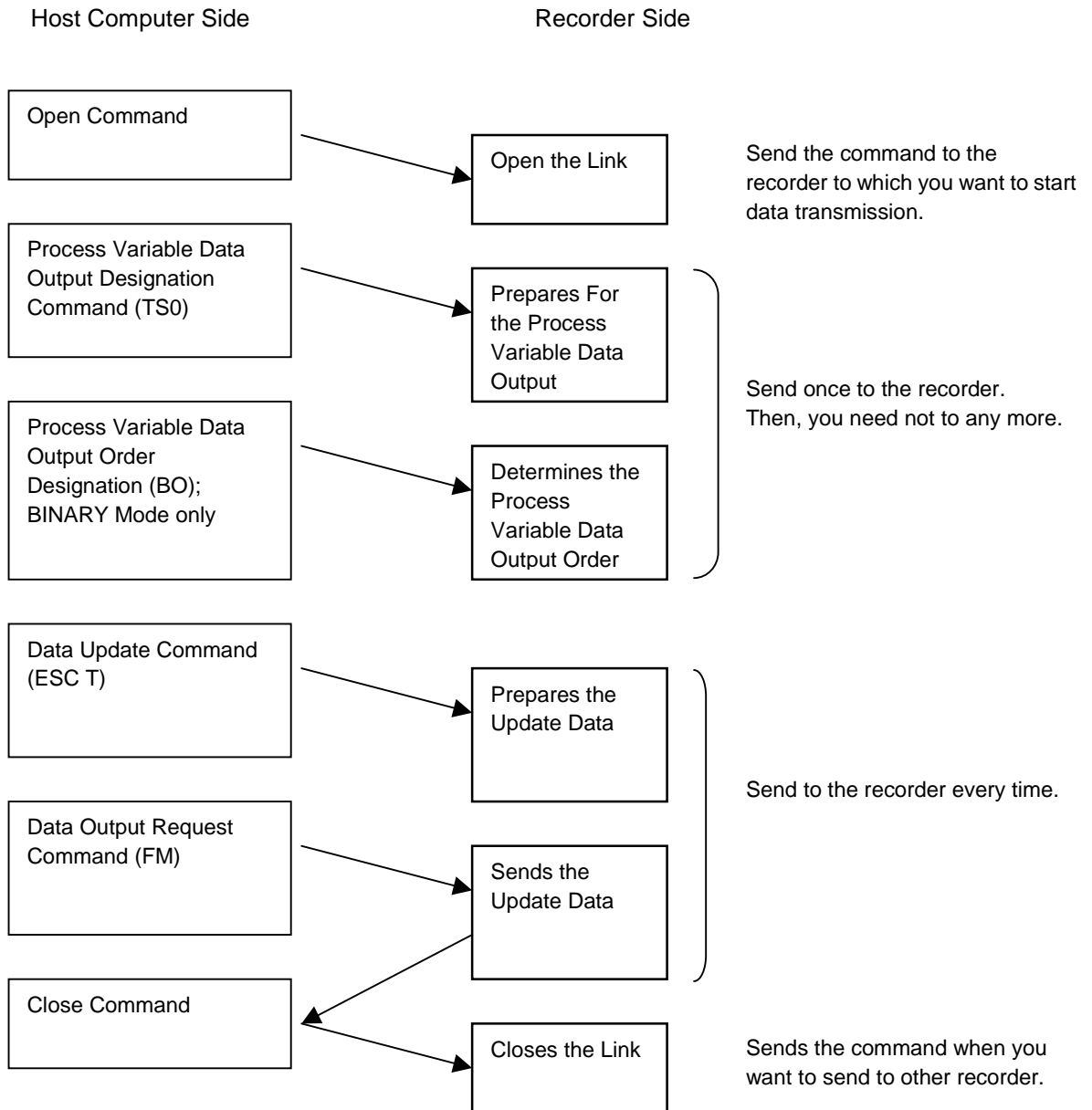

9. MAINTENANCE

Inspect the following maintenance items in order to use this instrument effectively.

- Inspection
- Cleaning
- Replace Consumables
- Adjust Dot Printing Position
- Calibration

9.1 Inspection

Inspect the condition of operation to use effectively.

When a defect is found, see Chapter 10 "Trouble Shooting".

- ◆ Trend recording deflected?
- ◆ Are recording indication done properly?
 - Any big error in indicated values or dot printing position?
 - Any improper dot printing?
 - Any blurred dot printing or printout?
 - Proper printout?
- ◆ Is the chart paper feed properly?
 - Is the chart paper folded properly?
 - Aren't the feed holes in the chart paper torn off or broken?
 - Is the chart speed correct?
- ◆ Is there any abnormal sound?

9.2 Cleaning

Many parts of this instrument are plastic. Use a dry cloth to wipe the parts should be clean.

[Note]

Do not use any organic solvent.

9.3 Replacing Consumables

In order to use this instrument effectively, replace the consumable parts as shown the following table.

No.	Name	Type	Period	Remarks	Quantity
1	Chart paper	HZCGA0105EL001	33 days	Chart speed is 20mm/h	1
2	Ribbon cassette	WPSR188A000001A	3months	Chart speed is 20mm/h	1

[Note]

- ① When recording with a ribbon, a dot printing color phases out. To ensure clear recording, replace the ribbon cassette as possible.
- ② Use the ribbon cassette within one year after its purchase. Due to evaporation of ink, a printing color phases out as time goes on.

9.4 Adjust Dot Printing Position (Point Calibration)

The following describes how to adjust a printing position on the chart paper.

You are well advised to adjust it annually in order to maintain recording accuracy.

How to Adjust

It is unnecessary to enter the reference. With the apparatus left in the working conditions, make adjustment according to the instructions in 7.2.11 Point Calibration.(See page 78)

9.5 Calibration (Data Calibration)

Calibrate a process variable input every year in order to keep measurement accuracy.

[Note]

Prior to calibration, warm up for 30 minutes or more after power-on.

Devices required for calibration

- Precision voltage(current) generator (Jointly use a digital voltmeter with accuracy of $\pm 0.02\%$ or less as required)
- Precision dial resistor

(1) Calibration of Voltage

Conduct calibration in case of voltage, current or thermocouple input. For thermocouple input, calibrate reference junction compensation together.

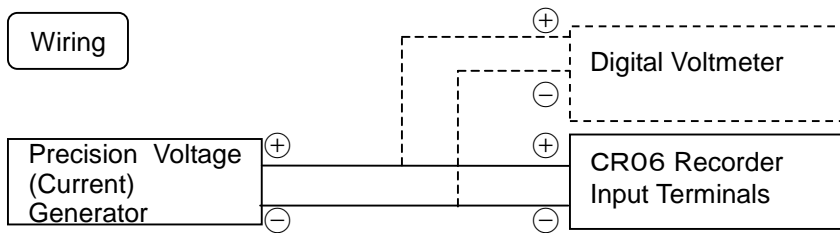

Conduct calibration according to the instructions in 7.2.12 Data Calibration (Calibration of the voltage).(See page 79)

[Note]

- ① Calibrate at any one channel.
- ② When a shunt resistor is attached to the input terminal block in case of current input, detach it prior to calibration.

(2) Calibration of Resistance temperature detector

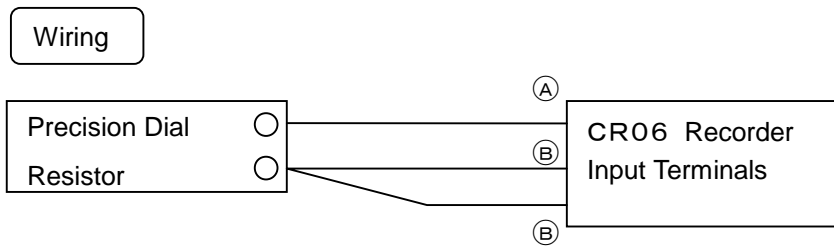

Conduct calibration according to the instructions in 7.2.12 Data Calibration (Calibration of the resistance temperature detector).(See page 80)

[Note]

A resistance value should not disperse greater than $6 \text{ m}\Omega$ from one wire to another.
When calibrate RTD for a channel, the input terminals of the other channels are shortcut.
Recording requires RTD calibration for every channel

10. TROUBLESHOOTING

10.1 Troubleshooting

10.1.1 Trouble Items

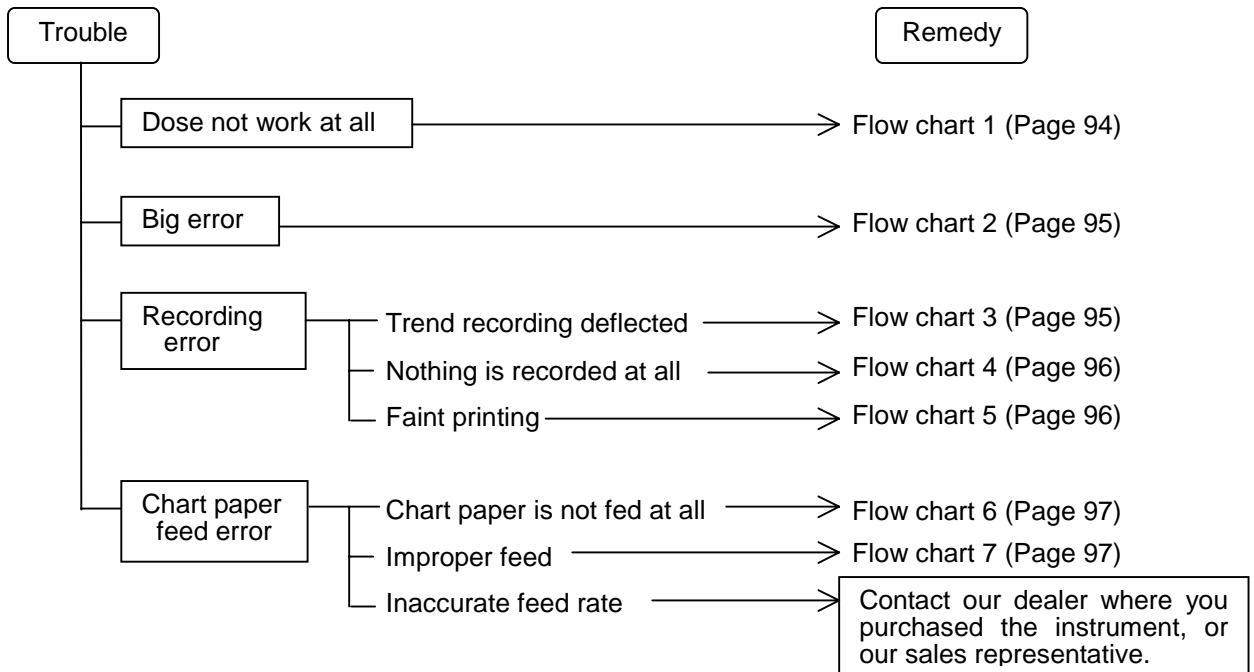

10.1.2 When the Recorder Dose not Work at All

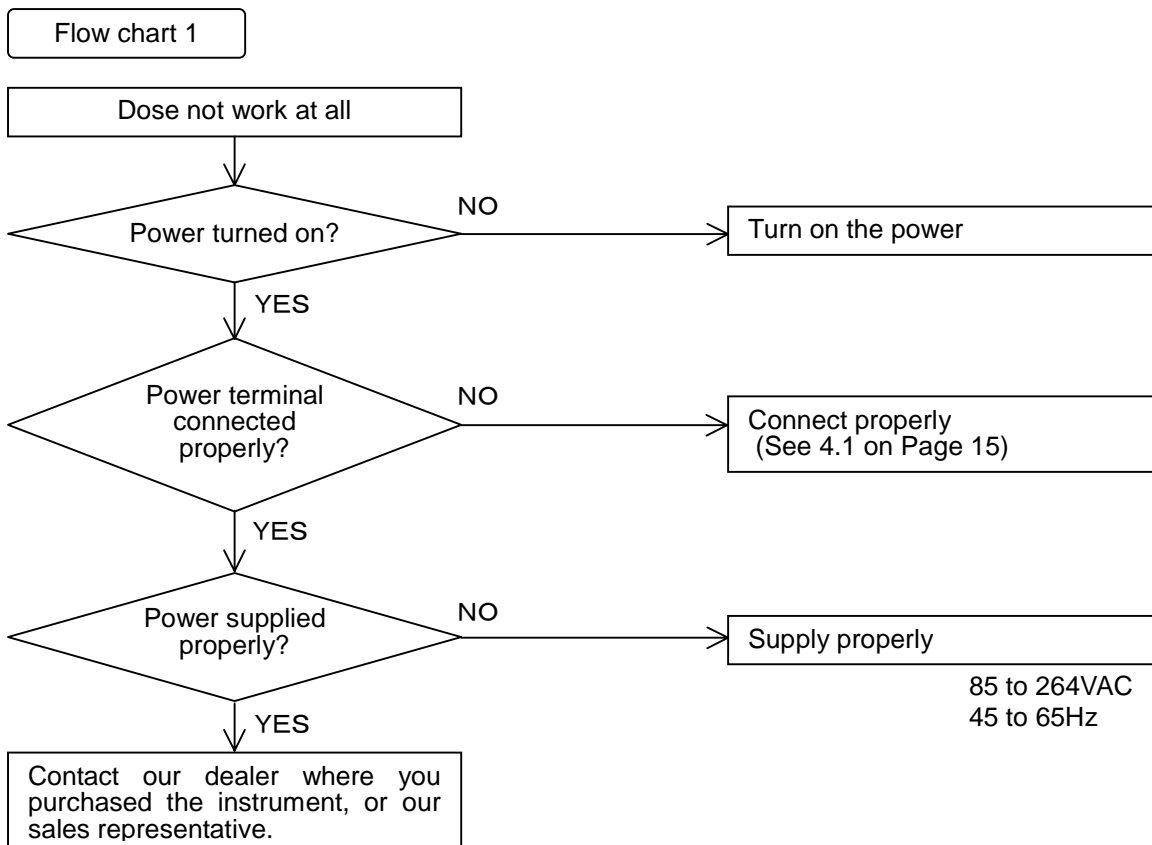

10.1.3 When there is a Big Error

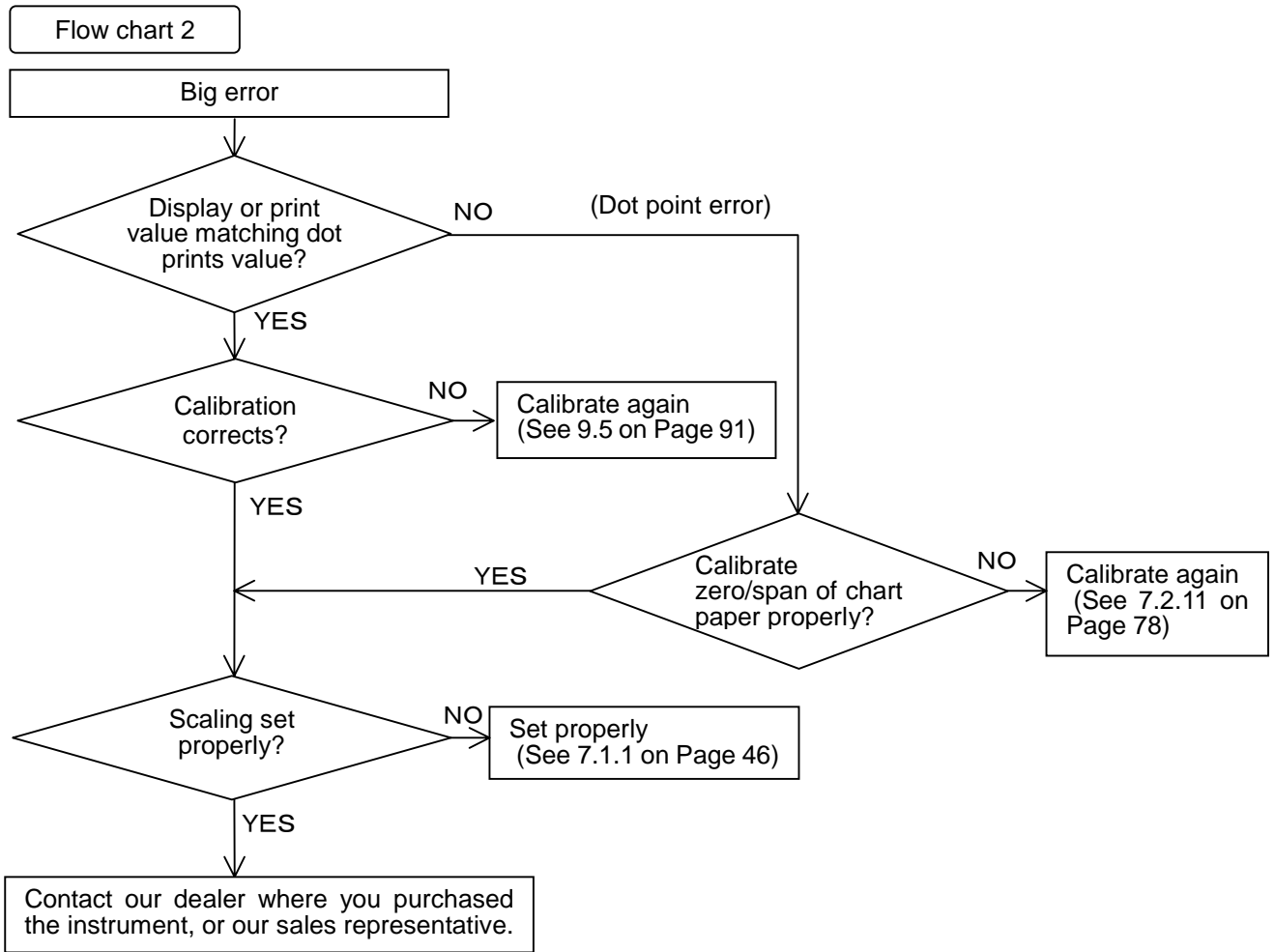

10.1.4 When the Trend Recording Deflected

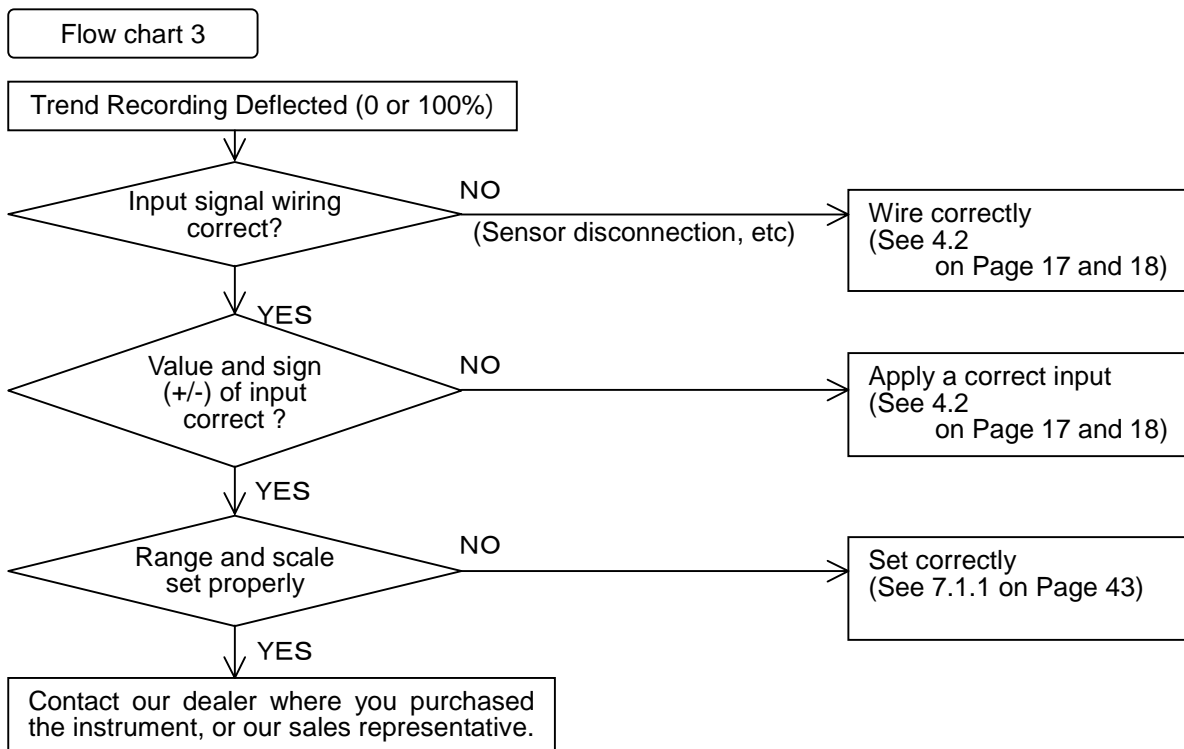

10.1.5 When Records Nothing

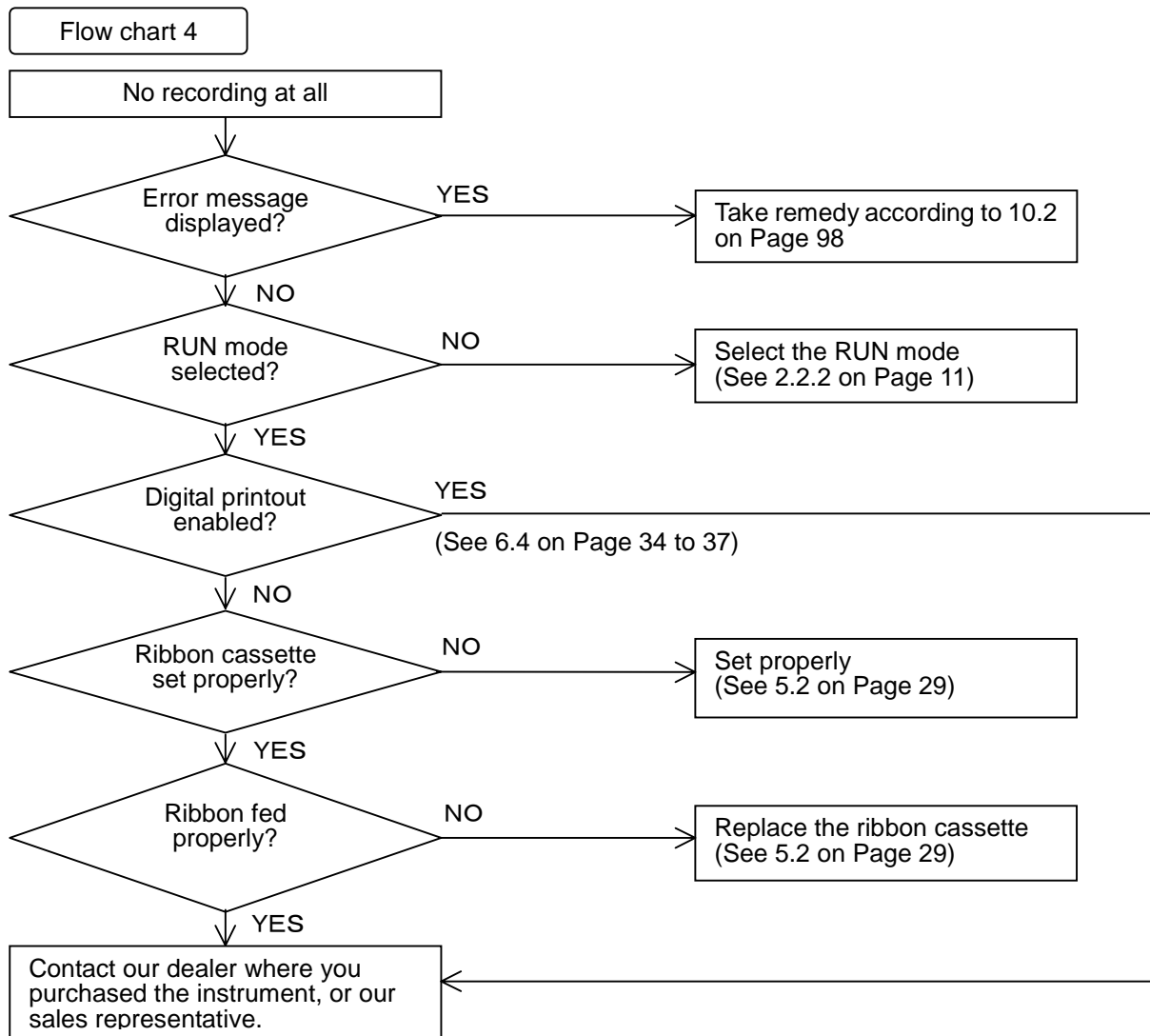

10.1.6 When Recording is Faint

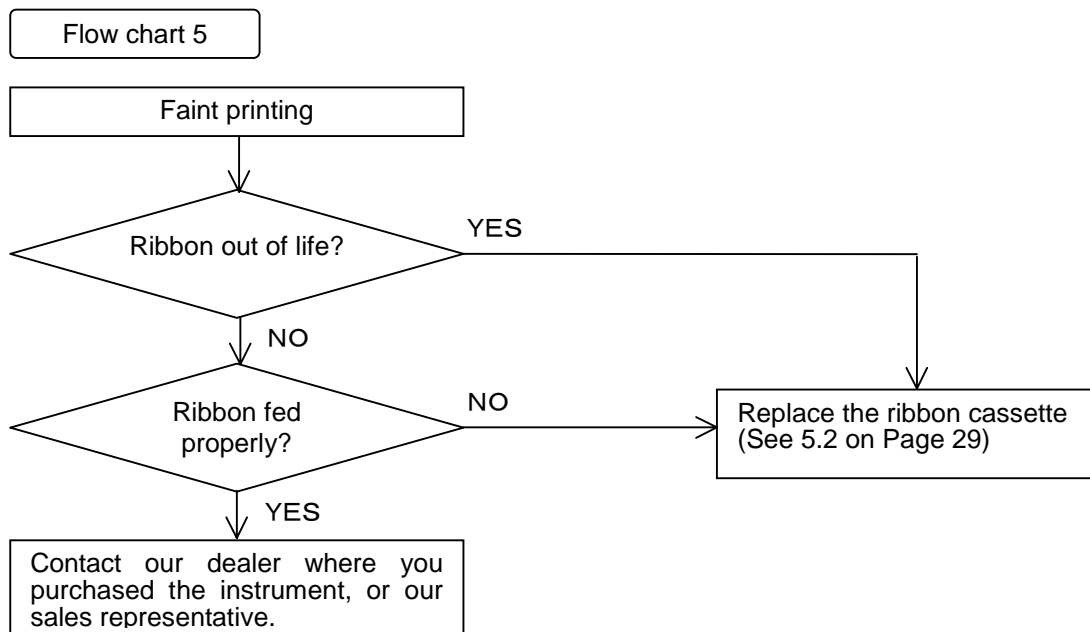

10.1.7 When the Chart Paper is not fed at All

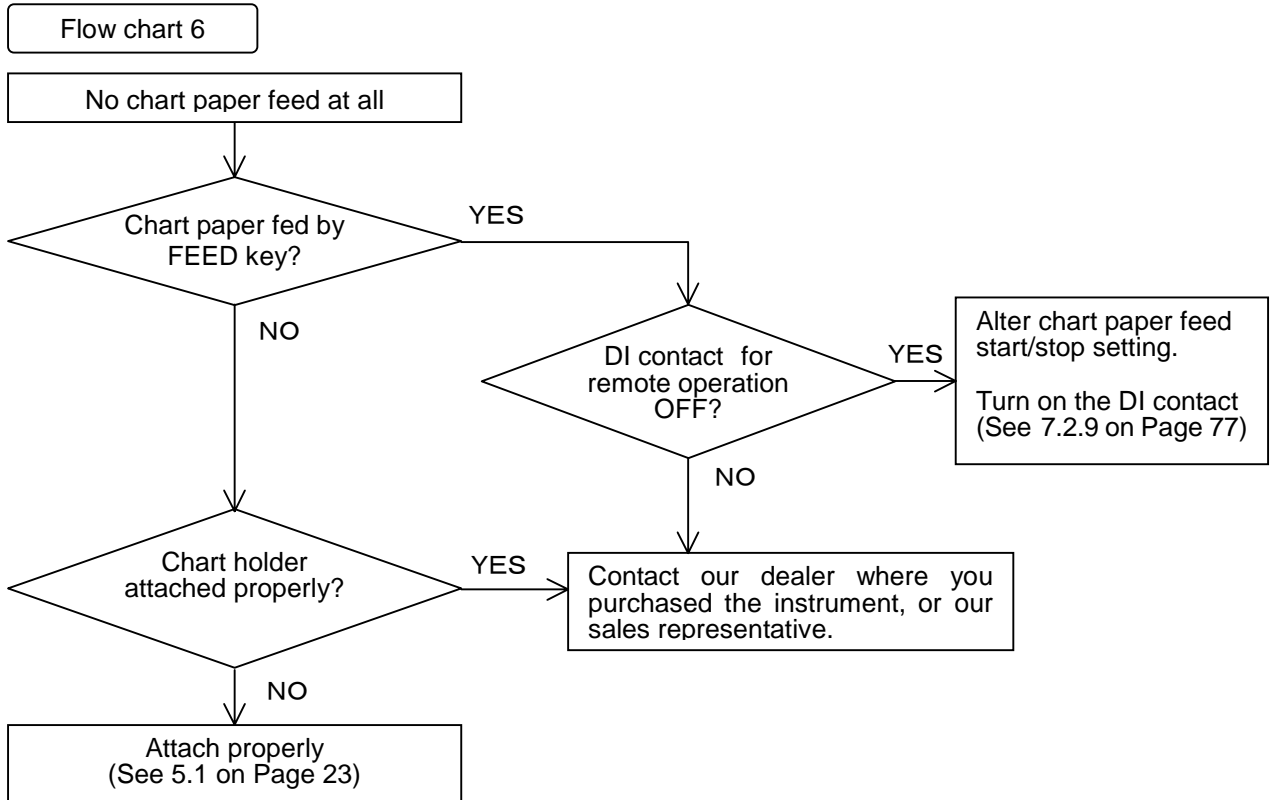

10.1.8 When the Chart Paper is not fed Properly

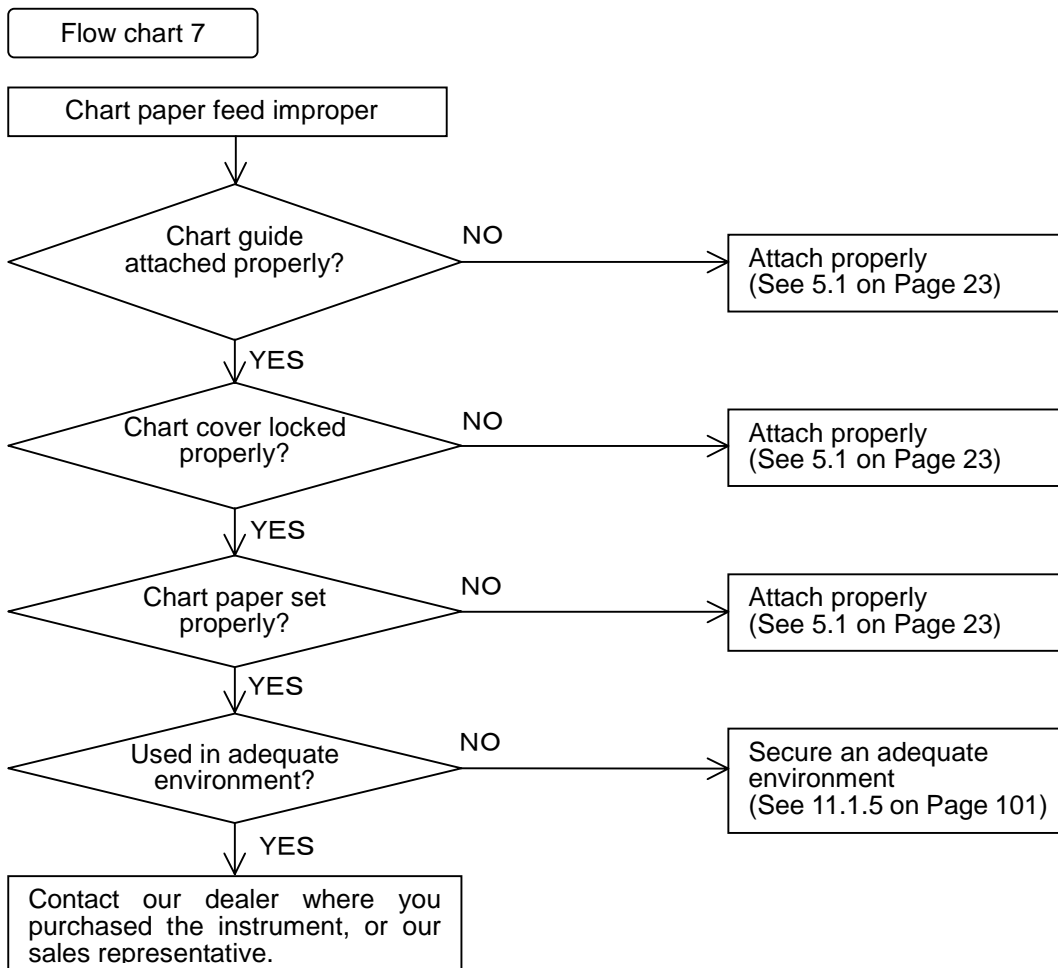

10.2 Self Diagnostics Function (ERROR)

This instrument always makes a self diagnostics on the items listed in Table 10.1 below. When an error is found in the self diagnostics results, a relevant error number is displayed.

10.2.1 Self Diagnostic Items

Table 10.1 Status output list

Type	Error message	Parts	Diagnostic	Remedy
Hard ware error	E E r r 0 1	Zero point sensor	Zero point position of servomotor cannot be detected.	Contact our dealer where you purchased the instrument or our sales representative.
	E E r r 0 2	ADC	AD conversion end error, Initializing error	
	E E r r 0 3	IC for clock	The clock battery runs down[Note1]	
	E E r r 0 4	WDT	Watchdog timer error	
	E E r r 0 5	E E P W R I T E W R I T E	Non-volatile memory Writing error	
	E E r r 0 6	E E P R E A D 1	Non-volatile memory Reading error (Setup data)	
	E E r r 0 7	E E P R E A D 2	Non-volatile memory Reading error (Engineering data)	
	E E r r 0 8	E E P R E A D 3	Non-volatile memory Reading error (ADC Calibration data)	
Operation error	E E r r 2 1	Area error	Input value is over the setting range.	Set properly
	E E r r 2 2	Time error	Clock time setting error	
	E E r r 2 3	Setting range error	Setting the channel (CH1) which cannot set up the sum/difference/average operation.	
	E E r r 2 4	Area error	Span L \geq Span R	
	E E r r 2 5	Area error	Scale L \geq Scale R	
	E E r r 2 6	Area error	Zone L \geq Zone R or Zone R – Zone L is less than 5mm.	
	E E r r 2 7	Setting channel error	The reference channel range of the sum/difference/average operation is except Volt, TC, RTD and SCALE.	
	E E r r 2 8	All channels skip error	Setting the Skip all channels.	
other	E E r r 4 1	Calibration value input error	It is not calibrating to the specified input.	Calibrate a correct input.

[Note1] The lifetime of the cell assumes about 10 years but sometimes depends on the use environment.

10.2.2 Error Display

- When multiple errors are encountered, their error numbers are displayed with automatic scrolling.
- When an error restores, an error display can be canceled to the input of the “RUN” key.



CAUTION

While indicates an error, dose not indicate Auto, Manual and Date/Time.

11. SPECIFICATIONS

11.1 Common Specifications

11.1.1 Input Signal

DC voltage : ± 10 , 0 to 20, 0 to 50, ± 200 mV DC, ± 1 , 0 to 5, ± 10 V DC

Thermocouple : B, R, S, K, E, J, T, C, Au-Fe, N, PR40-20, PL II, U, L
(Thermocouples not to be connected to hazardous voltage or equipment.)

Resistance temperature detector : Pt100, JPt100

DC current : 4 to 20mA DC (External shunt resistor: $250\ \Omega$ <charged:HMSU3081A11>)

11.1.2 Performance and Characteristics

Digital accuracy rating : See 11.2.1

Input impedance : $10M\ \Omega$ min. in mV, TC input (without burnout)
 $200k\ \Omega$ min. in mV, TC input (with burnout)
 $1M\ \Omega$ min. in voltage input
 $250\ \Omega$ (shunt resistance : external <charged:HMSU3081A11>)
in mA input

Allowable signal source resistance
: $10k\ \Omega$ max. in mV, TC input (without burnout)
 $100\ \Omega$ max. in mV, TC input (with burnout)
 $1k\ \Omega$ max. in Voltage input
 $10\ \Omega$ max.(per line) in Resistance temperature detector input

Normal mode rejection ratio : 60dB min.(50/60 \pm 0.1Hz)

Common mode rejection ratio : 140dB min.(50/60 \pm 0.1Hz)

Isolation resistance : 0.5kV DC $20M\ \Omega$ min. between the each terminal and grounding terminal

Withstand Voltage : 1.5kV AC for 1 minute between the power terminal and grounding terminal
: 0.5kV AC for 1 minute between the input terminal and grounding terminal
: 0.2kV AC for 1 minute between the input terminals
Interchannel maximum noise voltage: 200 V AC at 50/60 Hz

Vibration resistance : 10 to 60Hz $1m/s^2$ max.

Shock resistance : $2m/s^2$ max.

Clock precision : ± 50 ppm max.

Chart feed accuracy : $\pm 0.1\%$ max.

11.1.3 Structure

Mounting : Panel mount(vertical panel)
Allowable backward inclination : Within 30°

Material(Color) : Case ; Polycarbonate(Black), Glass 10% UL94-V2
Door ; Polycarbonate UL94-V2(Clear)
; Dust-proof, drip-proof (Complies with the IEC529-IP65) not evaluated as part of Underwriters Laboratories Listing certification.

11.1.4 Power Source

Rated supply voltage range : 100 to 240V AC
Working supply voltage range : 85 to 264V AC
Rated power frequency : 50/60Hz
Working frequency range : 45 to 65Hz

Table 11.1 Power consumption

	100VAC	Max. power consumption
6-dot recorder	About 25VA	About 30VA

11.1.5 Normal Operating Conditions

Ambient temperature : 0 to 50°C
Ambient humidity : 20 to 80%RH
Supply voltage : 85 to 264V AC
Supply frequency : 45 to 65Hz
Vibration : 10 to 60Hz 0.2m/s² max.
Shock : Unacceptable
Magnetic field : 400A/m max. (DC and AC: 50/60Hz)
Noise : Normal mode(50/60Hz)
DC current, Thermocouple; Peak value lower than the span width
of the measurement range
Resistance temperature detector ; 50mV max.
Common mode (50/60Hz) ; 250V AC max.
Interchannel maximum noise voltage: 200 V AC at 50/60 Hz

Posture : Allowable backward inclination : within 30°, Right-and-left level
Warming up time : 30 minutes min. from the time of a power-on injection

11.1.6 Alarm (Relay Output is Optional)

Outputs	: 6 point (Built-in option, normally open)
Alarm types	: 2 types (H, L), total 4 levels/channel
Contact point capacity	: 250V AC, 3A max. (Resistive load) 30V DC, 3A max. (Resistive load) 125V DC, 0.5A max. (Resistive load)
Hysteresis width	: 0.5%
Setting accuracy	: Digital display accuracy

11.1.7 Safety Standard and EMI Standard

Electrical safety	: IEC1010-1, UL3101-1 Installation category II and pollution degree 2.
Emissions	: EN55011 Group1 Class A
Immunity	: EN50082-2

11.1.8 DI Function (Option)

Set up point is a maximum of 3.

11.1.9 Paper-empty Detecting Function (Option)

Detects the Paper-empty to output an alarm.

11.2 Standard Setting Specifications

11.2.1 Measurement Range

The arbitrary setup is possible by the operation key.

A digital accuracy rating is as Table 11.1 at Reference operating conditions. It is shown below.

Reference operating conditions	: Temperature	: 23 ±2°C
	Humidity	: 55 ±10%RH
	Power source voltage	: 85 to 264V AC
	Electric wave frequency	: 50/60%Hz ±1%
	Warming up time	: 30 minutes min.

The performance in the state where nothing is vibration and a shock.

Terminal block reference junction compensation accuracy is not included in the digital accuracy rating.

It is shown below.

Terminal block reference junction compensation accuracy

◇B, R, S, Au-Fe, PR40-20 : ±1°C

◇K, E, J, T, C, N, PL II, U, L : ±0.5°C

Table 11.2 Measurement Range

Type	RANGE	Measurement range	Measurement		
			Digital		Analog
			Accuracy	Max. resolution	Accuracy
DC voltage DC contact Input		-10 to 10mV	±(0.2% of rdg + 3digits)	10 μV	
		0 to 20mV	±(0.2% of rdg + 3digits)	10 μV	
		0 to 50mV	±(0.2% of rdg + 2digits)	10 μV	
		-200 to 200mV	±(0.2% of rdg + 3digits)	100 μV	
		-1 to 1V	±(0.1% of rdg + 3digits)	1mV	
		0 to 5V	±(0.2% of rdg + 2digits)	1mV	
		-10 to 10V	±(0.3% of rdg + 3digits)	10mV	
		4 to 20mA	±(0.2% of rdg + 2digits)	0.01mA	
Thermocouple	B	0.0 to 1820.0°C	±(0.15% of rdg + 1°C) 400 to 600°C, ±2°C An accuracy is not compensated within a range of 0 to less than 400°C	0.1°C/0.18°F	Digital accuracy ±(0.3% of span)
		32.0 to 3308.0°F	±(0.15% of rdg + 1.8°F) 752 to 1112°F, ±3.6°F An accuracy is not compensated within a range of 32 to less than 752°F		
	R1	0.0 to 1760.0°C	±(0.15% of rdg + 1°C) ※0 to 100°C, ±3.7°C 100 to 300°C, ±1.5°C		
		32.0 to 3200.0°F	±(0.15% of rdg + 1.8°F) ※32 to 212°F, ±6.7°F 212 to 572°F, ±2.7°F		

Type	RANGE	Measurement range	Measurement		
			Digital		Analog
			Accuracy	Max. resolution	Accuracy
Thermocouple	R2	0.0 to 1200.0°C	±(0.15% of rdg + 0.8°C) ※0 to 100°C, ±3.7°C 100 to 300°C, ±1.5°C	0.1°C/0.18°F	Digital accuracy ±(0.3% of span)
		32.0 to 2192.0°F	±(0.15% of rdg + 1.44°F) ※32 to 212°F, ±6.7°F 212 to 572°F, ±2.7°F		
	S	0.0 to 1760.0°C	±(0.15% of rdg + 1°C) ※0 to 100°C, ±3.7°C 100 to 300°C, ±1.5°C		
		32.0 to 3200.0°F	±(0.15% of rdg + 1.8°F) ※32 to 212°F, ±6.7°F 212 to 572°F, ±2.7°F		
	K1	-200.0 to 1370.0°C	±(0.15% of rdg + 0.7°C) ※-200 to -100°C, ±(0.15% of rdg + 1°C)		
		-328.0 to 2498.0°F	±(0.15% of rdg + 1.3°F) ※-328 to -148°F, ±(0.15% of rdg + 1.8°F)		
	K2	-200.0 to 600.0°C	±(0.15% of rdg + 0.4°C) ※-200 to -100°C, ±(0.15% of rdg + 1°C)		
		-328.0 to 1112.0°F	±(0.15% of rdg + 0.7°F) ※-328 to -148°F, ±(0.15% of rdg + 1.8°F)		
	K3	-200.0 to 300.0°C	±(0.15% of rdg + 0.3°C) ※-200 to -100°C, ±(0.15% of rdg + 1°C)		
		-328.0 to 572.0°F	±(0.15% of rdg + 0.5°F) ※-328 to -148°F, ±(0.15% of rdg + 1.8°F)		
	E1	-200.0 to 800.0°C	±(0.15% of rdg + 0.5°C)		
		-328.0 to 1472.0°F	±(0.15% of rdg + 0.9°F)		
	E2	-200.0 to 300.0°C	±(0.15% of rdg + 0.4°C)		
		-328.0 to 572.0°F	±(0.15% of rdg + 0.7°F)		
	E3	-200.0 to 150.0°C	±(0.15% of rdg + 0.3°C)		
		-328.0 to 302.0°F	±(0.15% of rdg + 0.5°F)		
	J1	-200.0 to 1100.0°C	±(0.15% of rdg + 0.5°C) ※-200 to -100°C, ±(0.15% of rdg + 0.7°C)		
		-328.0 to 2012.0°F	±(0.15% of rdg + 0.9°F) ※-328 to -148°F, ±(0.15% of rdg + 1.3°F)		
	J2	-200.0 to 400.0°C	±(0.15% of rdg + 0.4°C) ※-200 to -100°C, ±(0.15% of rdg + 0.7°C)		
		-328.0 to 752.0°F	±(0.15% of rdg + 0.7°F) ※-328 to -148°F, ±(0.15% of rdg + 1.3°F)		
J3	-200.0 to 200.0°C	±(0.15% of rdg + 0.3°C) ※-200 to -100°C, ±(0.15% of rdg + 0.7°C)			
	-328.0 to 392.0°F	±(0.15% of rdg + 0.5°F) ※-328 to -148°F, ±(0.15% of rdg + 1.3°F)			

Type	RANGE	Measurement range	Measurement			
			Digital		Analog	
			Accuracy	Max. resolution	Accuracy	
Thermocouple	T1	-200.0 to 400.0°C	±(0.15% of rdg + 0.5°C) ※-200 to -100°C, ±(0.15% of rdg + 0.7°C)	0.1°C/0.18°F	Digital accuracy ±(0.3% of span)	
		-328.0 to 752.0°F	±(0.15% of rdg + 0.9°F) ※-328 to -148°F, ±(0.15% of rdg + 1.3°F)			
	T2	-200.0 to 200.0°C	±(0.15% of rdg + 0.4°C) ※-200 to -100°C, ±(0.15% of rdg + 0.7°C)			
		-328.0 to 392.0°F	±(0.15% of rdg + 0.7°F) ※-328 to -148°F, ±(0.15% of rdg + 1.3°F)			
	C	0.0 to 2320.0°C	±(0.15% of rdg + 1°C)			
		32.0 to 4208.0°F	±(0.15% of rdg + 1.8°F)			
	Au-Fe	1.0 to 300.0K	±(0.15% of rdg + 1K) ※1 to 20 K, ±2.4 K			0.1K
	N	0.0 to 1300.0°C	±(0.15% of rdg + 0.7°C)			0.1°C/0.18°F
		32.0 to 2372.0°F	±(0.15% of rdg + 1.3°F)			
	PR40-20	0.0 to 1880.0°C	±(0.15% of rdg + 1°C) ※0 to 300°C, ±37.6°C 300 to 800°C, ±18.8°C			
		32.0 to 3416.0°F	±(0.15% of rdg + 1.8°F) ※32 to 572°F, ±67.7°F 572 to 1472°F, ±33.8°F			
	PL II	0.0 to 1390.0°C	±(0.15% of rdg + 0.7°C)			
		32.0 to 2534.0°F	±(0.15% of rdg + 1.3°F)			
	U	-200.0 to 400.0°C	±(0.15% of rdg + 0.5°C) ※-200 to -100°C, ±(0.15% of rdg + 0.7°C)			
		-328.0 to 752.0°F	±(0.15% of rdg + 0.9°F) ※-328 to -148°F, ±(0.15% of rdg + 1.3°F)			
	L	-200.0 to 900.0°C	±(0.15% of rdg + 0.5°C) ※-200 to -100°C, ±(0.15% of rdg + 0.7°C)			
-328.0 to 1652.0°F		±(0.15% of rdg + 0.9°F) ※-328 to -148°F, ±(0.15% of rdg + 1.3°F)				
Resistance temperature detector	Pt100-1	-200.0 to 650.0°C	±(0.15% of rdg + 0.3°C)			
		-328.0 to 1202.0°F	±(0.15% of rdg + 0.6°F)			
	Pt100-2	-200.0 to 200.0°C	±(0.15% of rdg + 0.2°C)			
		-328.0 to 392.0°F	±(0.15% of rdg + 0.4°F)			
	JPt100-1	-200.0 to 630.0°C	±(0.15% of rdg + 0.3°C)			
		-328.0 to 1166.0°F	±(0.15% of rdg + 0.6°F)			
JPt100-2	-200.0 to 200.0°C	±(0.15% of rdg + 0.2°C)				
	-328.0 to 392.0°F	±(0.15% of rdg + 0.4°F)				

B,R,S,K,E,J,T,N :JIS C 1602-1995(IEC584-1)
 C :Made by "Hoskins" (WRe5-26)
 Au-Fe :ASTM COMMITTEE-20 ON TEMPERATURE MEASUREMENT
 PR40-20 :ASTM E1751-1995
 PL II :ASTM E1751-1995
 U :DIN43710 :1985(Cu-CuNi)
 L :DIN43710 :1985(Fe-CuNi)
 Pt100 :JIS C 1604-1997(IEC751)
 JPt100 :(JIS C 1604-1981)

11.2.2 The Accuracy at the Computation

(1) Scaling

The accuracy rating at the scaling is as following formula.

Scaling accuracy (digits) = Range accuracy rating (digits) × Scaling factor + 2 digits

$$\text{But, Scaling factor} = \frac{\text{Scaling span (digits)}}{\text{Measurement range span (digits)}}$$

Example 1) When VOLT range is $-1.000 \sim 1.000\text{V}$ and Scaling range is $0.00 \sim 100.00$.

Range accuracy rating = $0.1\% \times 1.000\text{V} + 3$ digits

$$\text{(Input } +1.000\text{V)} = 4 \text{ digits}$$

$$\text{Scaling factor} = \frac{10000 - 0}{1000 - (-1000)} = 5$$

$$\begin{aligned} \text{Therefore, Scaling accuracy} &= \pm(4 \times 5 + 2) \\ &= \pm 22 \text{ digits} \end{aligned}$$

$$\begin{aligned} \text{Analog recording accuracy} &= \pm \left[4 + \{1000 - (-1000)\} \times \frac{0.3}{100} \right] \\ &= \pm 10 \text{ digits} \\ &= \pm 0.01\text{V} \end{aligned}$$

Example 2) When Type K is $0.0 \sim 200.0^\circ\text{C}$ and Scaling is $0.00 \sim 200.00$.

Range accuracy rating = $0.15\% \times 200.0 + 0.3^\circ\text{C}$

$$\begin{aligned} \text{(Input } 200^\circ\text{C)} &= 0.6^\circ\text{C} \\ &= 6 \text{ digits} \end{aligned}$$

$$\text{Scaling factor} = \frac{20000 - 0}{2000 - 0} = 10$$

$$\begin{aligned} \text{Therefore, Scaling accuracy} &= \pm(6 \times 10 + 2) \\ &= \pm 62 \text{ digits} \\ &= \pm 0.62^\circ\text{C} \end{aligned}$$

(2) Square root computation

The square root computation is as following formula.

$$\text{Display value} = 10 \sqrt{\text{Process variable}}$$

Display value accuracy rating: \mathcal{E} , Process variable accuracy: e , and Process variable: x (convert into %).

$$\text{Display value} = 10 \sqrt{x \pm e} \doteq 10 \sqrt{x} \pm \frac{10e}{2\sqrt{x}}$$

$$\text{Therefore, Display value accuracy } \mathcal{E} = \frac{5e}{\sqrt{x}}$$

When input 4~20mA, the square root computation accuracy: \mathcal{E} is as following formula.

$$\begin{aligned} \text{Measuring 100\%} \quad \mathcal{E}_{100} &= \frac{5e}{\sqrt{100}} = \frac{5(0.2+0.125)}{10} = 0.16\% \text{ rdg} \\ \text{Measuring 50\%} \quad \mathcal{E}_{50} &= \frac{5e}{\sqrt{50}} = \frac{5(0.1+0.167)}{7.07} = 0.19\% \text{ rdg} \\ \text{Measuring 9\%} \quad \mathcal{E}_9 &= \frac{5e}{\sqrt{9}} = \frac{5(0.018+1.39)}{3} = 2.3\% \text{ rdg} \\ \text{Measuring 1\%} \quad \mathcal{E}_1 &= \frac{5e}{\sqrt{1}} = 5(0.002+12.5) = 62.5\% \text{ rdg} \end{aligned}$$

If the process variable is low as above, its accuracy rating is incorrect.

(3) Decade

The accuracy rating at the decade computation is defined the logarithm of display value. Normally, the accuracy rating is less than 1 digit and you cannot read by significant digit.

(4) Difference, Sum, and Average

The accuracy rating of Difference, Sum, and Average is as following formula.

Difference and Sum : Reference channel accuracy rating $\times 2$

Average : Reference channel accuracy rating

Example) When Reference channel VOLT is 00.00~10.00V and Difference is $-10.00 \sim 10.00$.

$$\begin{aligned} \text{Reference channel accuracy rating} &= \pm (0.3\% \times 10.00V + 3 \text{ digits}) \\ &= \pm (1000 \times 0.003 + 3) \\ &= \pm 6 \text{ digits} \end{aligned}$$

$$\text{Difference accuracy rating} = \pm 6 \times 2 = \pm 12 \text{ digits}$$

11.2.3 Individual Specifications

Table 11.3 Specification Items

Block	Item	Specification
Input Unit	Measuring Point	6
	Input Sampling	10s/6CH
	Display Interval	2.5s
Record & Printer	Recording Form	Wire dot (6-color ink ribbon)
	Printing Form	
	Recording Width	100mm
	Print Period	10s/6CH [Note 1]
	Chart paper	Length : 16m, Width : 114mm, Folding width : 40mm The length of the Clean Chart is 12 m.
	Chart speed	0, 1, 2, 3, 4, 5, 10, 15, 20, 25, 30, 40, 50, 60, 75, 80, 90, 100, 120, 150, 160, 180, 200, 240, 300, 360, 375, 450, 600, 720, 750, 900, 1200, 1500mm/h (Analog recording is not done during the chart speed setting 0mm/h.)
	Recording color	No.1(Purple), No.2(Red), No.3(Green), No.4(Blue), No.5(Brown), No.6(Black) [Note 2]
Printing color	Purple, Red, Green, Blue, Brown, Black	
Weight		1.5kg max.
Power consumption		25VA max. (at 100VAC)

[Note 1] Select the Dot Point Interval from 10, 20, 30 and 60 seconds for the setting.

[Note 2] Change in arbitrary colors in possible by setup.

11.2.4 Standard Functions

Table 11.4 Standard Functions

Item	Description
Analog indication	None
Analog recording	Makes analog recording with 6-color dot.
Engineering unit indication	None
Digital display	Indicates Channel No., Process variable data, Chart speed, Alarm setting value on the display.
Logging print	Prints Date, Time, Scaling, Chart speed, Process variable and Engineering unit at a programmed interval. With the setting, it is possible for the synchronous print/Asynchronous print to choose.
List print	Prints Chart speed, Sensor type, Measurement range, Engineering unit, Alarm setting value, Comment, Printing description, Logging print ON/OFF, Zone, Partial Compression/Expansion
Engineering list print	Prints Channel or Tag, Alarm function, Logging print ON/OFF, Reference time, Interval, Scaling print ON/OFF, Logging print Sync./Async., Alarm hysteresis, Burn out, DI function(Optional)
Affix print	Prints Channel number by the analog recording.
Manual print	Prints Measurement result by key input. Analog recording stops.
Dot print skip	Skips recording of an unused channel.
Programming	Programs Chart speed, Alarm setting value, Logging, Dot point skip, Date and Time.
Memory back up	A built-in lithium battery protects the clock function. The battery life is 10 years. (total power off period of the instrument : 5 years) A non-volatile memory stores setting data and calibration data.
Alarm	Sets 2 types (H, L) of alarms per channel. Sets a total of 4 level.
Chart speed	Selects Chart speed from 34 types.
Clock indication	Indicates Year, Month, Day, Hour and Minute. Sets the year in A.D, and adjusts leap year automatically.
Self diagnostics	Occurring some type of the defect to indicate "E Err * *". (* *: type of the defect)
Scaling	Indicates and record the input of a unification signal etc. is changed into the engineering scales.

11.3 Standard Setting Functions

11.3.1 Standard Setting Functions

Table 11.5 Standard Setting Functions

Function	Description
Burnout	To deflect over toward 100% with disconnecting input. Specifies the every channel's burnout. (DC voltage of $\pm 50\text{mV}$ max., TC input)
Tag Number	Sets a tag number by 7 figures every channel. (Prints at a logging print)
Reference Junction Compensation	Specifies an inside/outside of the Reference Junction Compensation.
Copy Function	Copies a channel setting up.
Setting input offset	Setting input offset is possible for every channel.
Zone Recording (Track Recording)	Specifies a recording area every channel to separate into Tracks.
Partial compression/expansion	Records Partial Compression/Expansion to 1-crease line every channel.
Decade Recording Indication	Records and indicates by 5 decades. It is 2 figures that the effective number to indicate and print.
Alarm Print	Prints Occurrence time, Occurrence channel, Setting No. and Alarm type in purple at occurring an alarm.
Alarm Recovery Print	Prints Recovery time, Recovery channel, Setting No. and Alarm type in purple at recovering an alarm.
Computation	Computes Square root.
Interchannel Computation	Computes Sum, Difference and Average computation.
Alarm Hysteresis Width	Sets an alarm hysteresis width 0% FS or 0.5% FS.

11.4 Optional Functions

11.4.1 Remote Function of DI

Function	Description
Chart Feed Start/Stop	Starts with turning to ON. Stops with turning to OFF.
Changing Chart Speed	Changes 1st with turning to ON and 2nd with OFF.
Comment Print (Sync./Async.)	Prints Comment with turning to ON.
Manual Print (Sync./Async.)	Prints Manual Print with turning to ON.
Date and Time Print (Sync./Async.)	Prints Date and Time with turning to ON.

11.4.2 Alarm Board

6 relays

11.4.3 Communication unit

RS-232C(Standard)

RS-485(option)

For upgrade addition of 6 relay card

1. Open the door and remove chart holder from inner module.
2. Pinch and pick up the hook from the case bottom and hang finger into square hole then pull out inner module.
(If hook cannot be off, use flat screwdriver to be off).

Note 1: When pull out inner module, do not hold ribbon holder and printer.

Note 2: Also please note to handle with care FPC cable when pull out inner module.

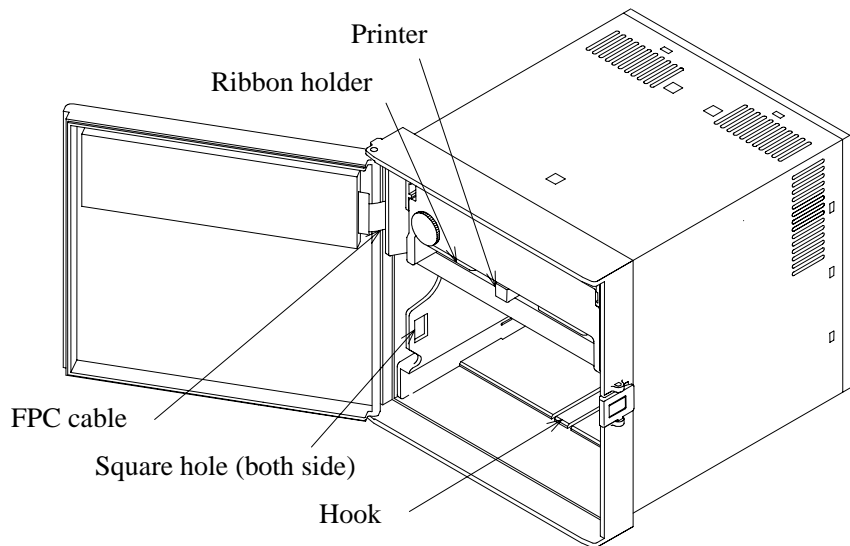

3. Location of each card / board

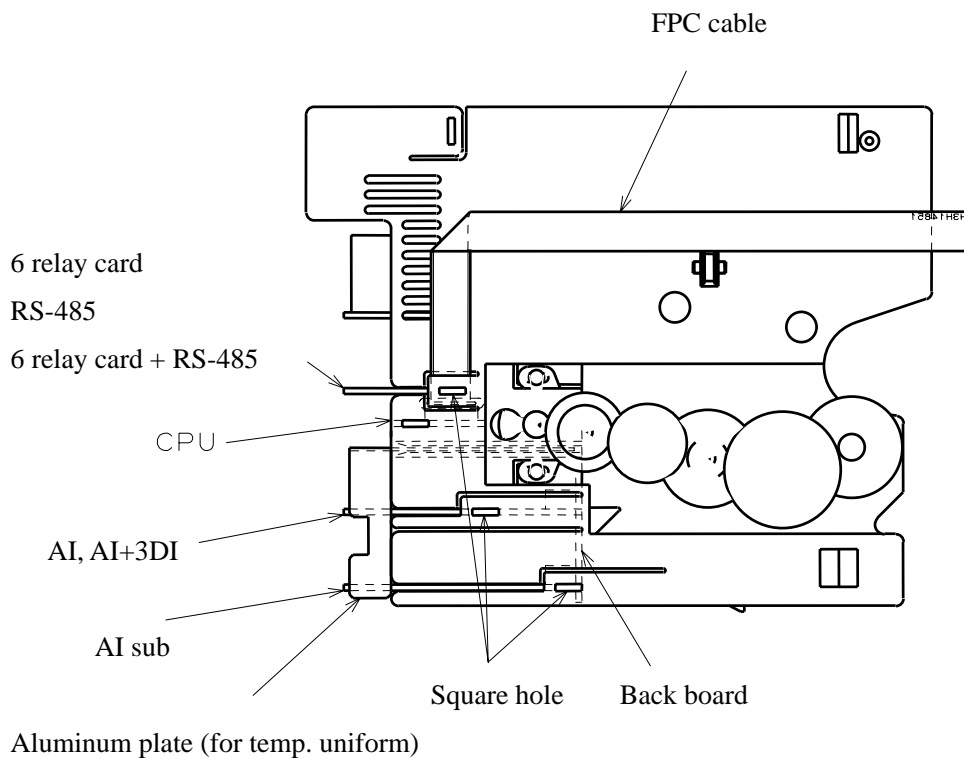

4. Addition upgrade of 6 relay card HMSU3555A01:

Disconnect FPC cable for the display from connector (CN6) in the CPU. Connect with cable for card connector and CPU connector (CN7). Cable both ends are same and common. It is easier to connect with CPU if form the cable before connecting.

Connect FPC cable for the display with CPU connector (CN6).

- MAKE SURE THAT FPC CABLE TO BE INSERTED TO THE END OF THE CONNECTOR AND STRAIGHTLY CONNECTED. Obliquely connected then it causes faults.

Put 6 relay board on the part indicated as bellow.

Note: Make sure that the cable and FPC cable not to be caught by the board. Check again conditions of the connection of FPC cable.

Make sure that FPC cable for the display to be positioned and passed above 6 relay board.

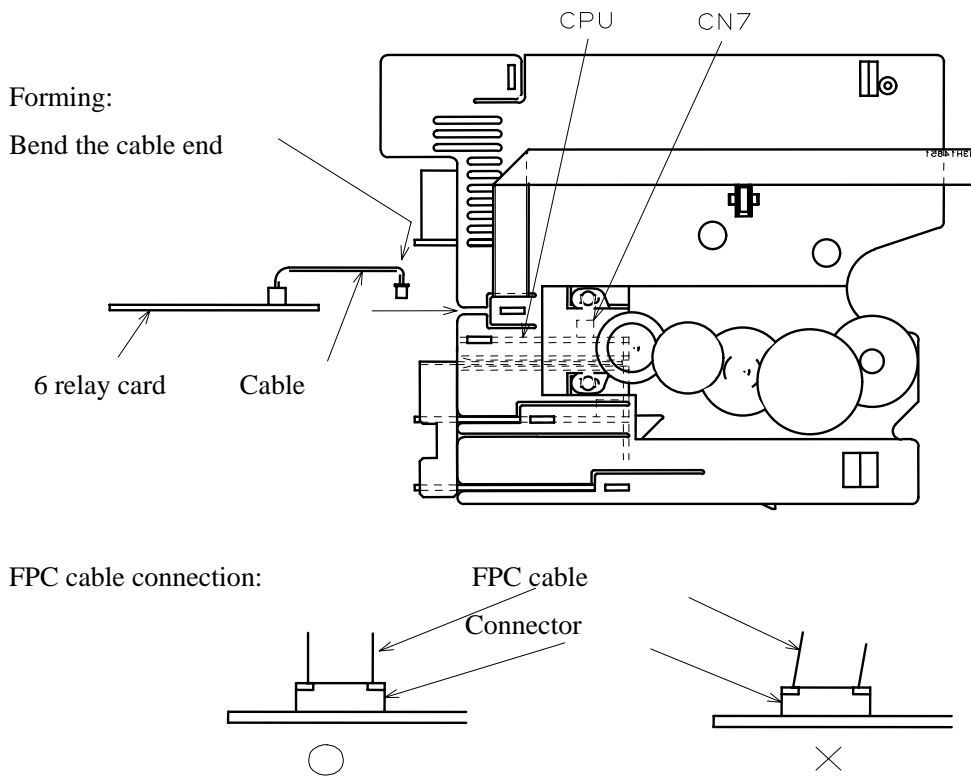

Board type	FDC's partnumber	Manuf. part number
6 relay board	910063655A01	HMSU3655A01
RS-485	910063655A02	HMSU3655A02

5. Adjust aluminum plate to guide to put it to inner module

(Note: When inserting inner module, if aluminum plate is existing in the inside case, print board would be damaged)

Insert the inner module with taking care to not damage FPC cable. Softly bent FPC cable then insert with inner module.

- DO NOT PUSH RIBBON HOLDER AND PRINTER IN INSERTING INNER MODULE.

After well inserted, push hook into square hole of the case bottom and make sure it fits well.

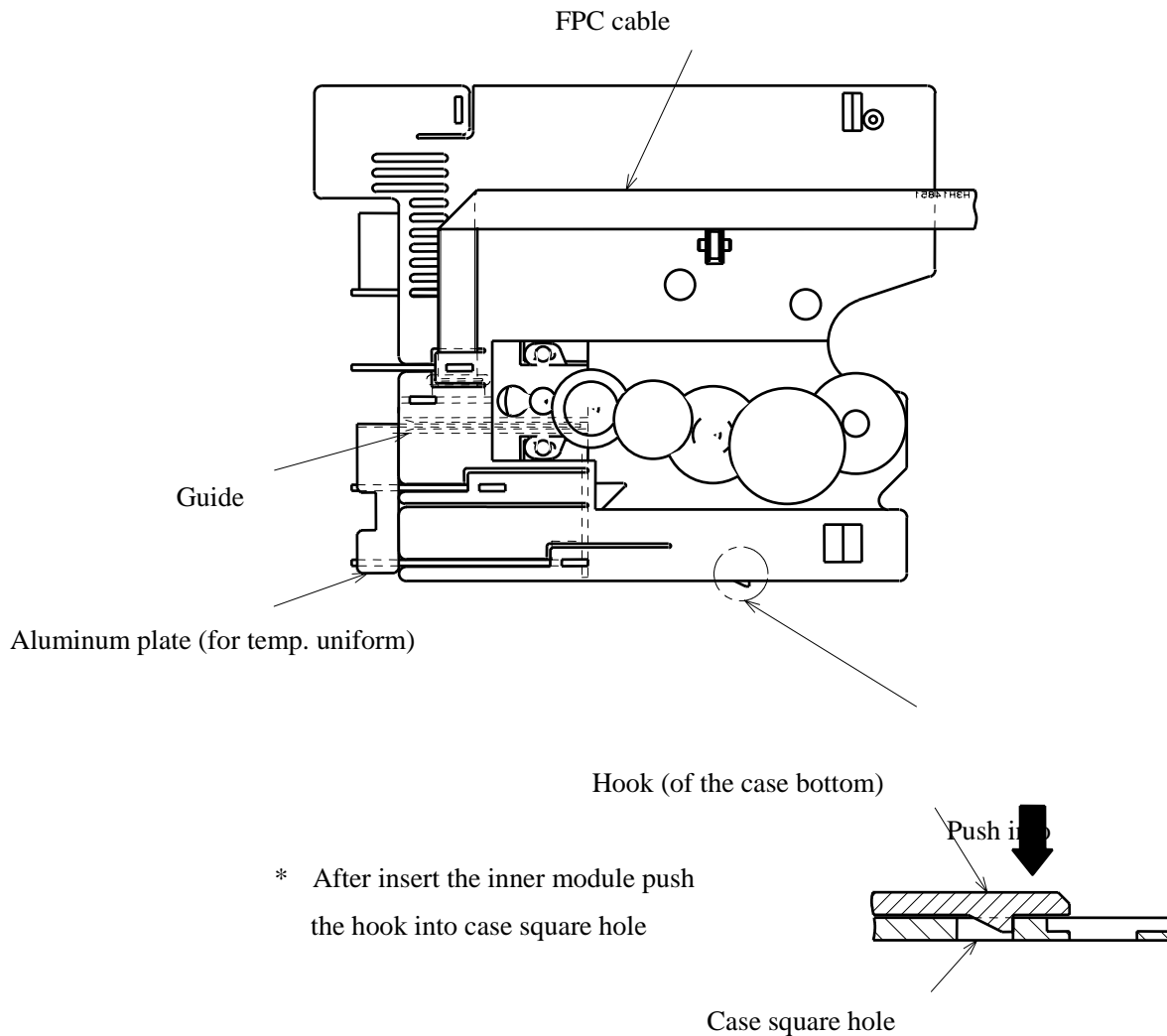

- * After insert the inner module push the hook into case square hole

6. After installation make sure, by opening/closing the door, FPC cable will smoothly slide in a space between case and inner module. If not slid well, please reinstall inner module again.

7. Put chart holder into the case and turn the power on then make sure that the recorder works in normal action.

8. Calibrate the recorder if required according as standard instruction manual.

CR06 Strip Chart Recorder



Addendum on Paper Out Sensor Option

1. Relay Output option is required when ordering the Paper Our Sensor option.
2. Upon a paper out detection, Relay 1 only WILL energize. No program or setup is required for this operation.
3. This relay could be use for an audible indication to alert operators of this condition.
4. Relay 1 can also still be programmed for either a High or Low alarm, in addition to operating as a Paper Out Relay.
5. The Alarm LED on display will NOT light during a paper out condition. Alarm light will energize if other program alarms (High/Low)
6. Relay alarm condition for Paper Our will ONLY clear once paper has been installed in unit.

Warranty:

Future Design Controls **CR06 Strip Chart Recorders** are warranted to be free from functional defects in materials and workmanship at the time the products leave Future Design Controls facilities and to conform at that time to the specifications set forth in the relevant Future Design Controls manual, sheet or sheets for a period of **Two years** after delivery to the first purchaser for use.

There are no expressed or implied Warranties extending beyond the Warranties herein and above set forth.

Limitations

Future Design Controls provides no warranty or representations of any sort regarding the fitness of use or application of its products by the purchaser. Users are responsible for the selection, suitability of the products for their application or use of Future Design Controls products.

Future Design Controls shall not be liable for any damages or losses, whether direct, indirect, incidental, special, consequential or any other damages, costs or expenses excepting only the cost or expense of repair or replacement of Future Design Control products as described below.

Future Design Controls sole responsibility under the warranty, at Future Design Controls option, is limited to replacement or repair, free of charge, or refund of purchase price within the warranty period specified. This warranty does not apply to damage resulting from transportation, alteration, misuse or abuse.

Future Design Controls reserves the right to make changes without notification to purchaser to materials or processing that do not affect compliance with any applicable specifications.

Return Material Authorization:

Contact Future Design Controls for Return Material Authorization Number prior to returning any product to our facility.

Future Design Controls, Inc.

7524 West 98th Place, P.O. Box 1196, Bridgeview, IL 60455 USA

888.751.5444 - Office:

888.307.8014 - Fax

866.342.5332 - Technical Support

E-mail: csr@futuredesigncontrols.com

Website: <http://www.futuredesigncontrols.com>